

General catalog





rose plastic

innovations in plastic packaging



1953 - 2023
70 years



Welcome to rose plastic,
Protective Packaging Pioneers

From a "one-man-show" to a global extended family, so to speak

Since the foundation of the company in 1953 by Ernst Rösler, my grandfather, at rose plastic we have consistently focused our activities on the needs and interests of our customers. This was the only way to achieve the growth that transformed our family business from its modest beginnings into the global player with international market significance that we are today.

Under the leadership of my father, Peter Rösler, rose plastic has made a name for itself worldwide as a pioneering provider of robust, well-designed protective plastic packaging. In addition to the entire world of precision tool manufacturers, our customers now include dozens of well-known companies from almost all industries.

However, one thing has remained unchanged – we are still a family business with consistent values and principles. Our primary focus remains your wishes and requirements. We are convinced that satisfied employees and customers are not only the basis for economic success, but also for long-term, mutually beneficial relationships.

Sincerely,

Thiemo Rösler
CEO, rose plastic AG



Everything you need from
a single source – worldwide

We are wherever you need us to be

With around 800 employees at 10 locations around the world, we are also near to our customers. For short distances, reliable logistics, and sustainable business practices.

Plastic packaging from rose plastic optimally protects your products and combines functionality with sales-promoting product presentation. Today, our product range comprises more than 4,000 packaging solutions for a vast range of applications. It includes plastic sleeves, boxes, cassettes, cases, transport and storage systems as well as practical accessories.

CORPORATE HEADQUARTERS
Germany

PRODUCTION LOCATIONS
Germany, USA, China, Brazil, India

SALES LOCATIONS
France, United Kingdom, Spain, Italy, South Korea

SALES PARTNERS
Poland, Turkey, Japan

Doing everything for yourself means you really have your hands full

From the idea to the finished package



Only the work we do ourselves meets our high standards. That's why we choose to control virtually every step within our business.

Our success has proven us right – our customers feel and appreciate the difference ...

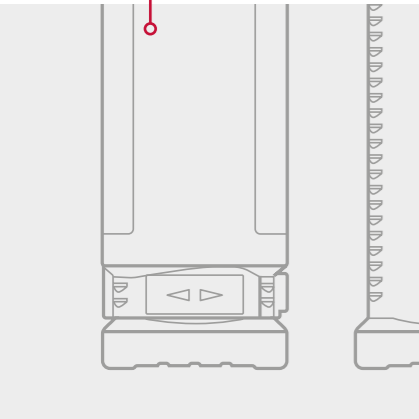

1 The idea

DESIGN AND DEVELOPMENT

A good product is first and foremost based on a good idea that not only takes the customer's wishes into account, but also often exceeds them. The experts in our highly efficient in-house development department take the design and construction of our packaging into their own hands right from the start. They and the proximity to our customers are the reasons for our well-designed, high-quality products.



2 The tool

TOOL SHOP

We produce our packaging using high-precision blow molding and injection molding tools. But who produces our tools? You can probably guess ... Naturally, we also do this ourselves – from the design right through to CNC-supported production. Because decades of experience have taught us the exact requirements for our production tools. Through the years, we have developed and integrated numerous special features that ensure superior process and product quality.

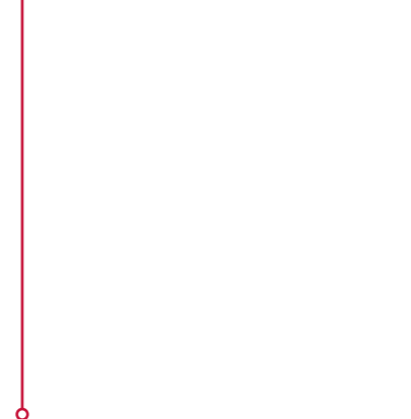

3 The tests

TECHNICAL CENTER

At our in-house technical center we put new tools to the acid test, carry out exhaustive production tests, and give valuable feedback to our development team and tool shop. Our colleagues in this department also perform exacting material tests and trials.



4 The series

PRODUCTION

Our packaging products only go into series production (injection molding and blow molding) once they have been fine-tuned and have successfully passed various tests and inspections. We have also introduced numerous special features into our production process. These allow us to work with higher process reliability in order to achieve higher product quality, while ensuring economical production. The same applies to our sorting department, where the finished products are thoroughly checked, tested and packed for safe transportation.

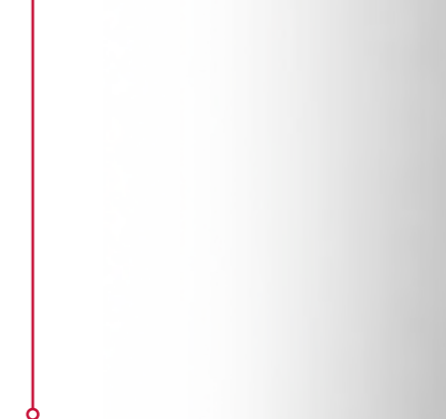

5 The logistics

STORAGE AND SHIPPING

Our warehouses, which are designed for maximum capacity, and our experienced employees ensure that our products are well packed and reach you as soon as possible. Which in turn enables you to quickly deliver well-packaged products to your own customers.



Sustainability. Make the right choice!

More than just a fleeting trend



„rose plastic has been setting new standards with innovative packaging. We also want to be leaders in the area of sustainability.“

THIEMO RÖSLER

1 General information

DID YOU KNOW...

...that plastic packaging consumes comparatively few resources during its production? And that its low weight helps to reduce unnecessary emissions during transport? Studies show that, if plastic packaging were replaced with suitable alternative materials, energy requirements would more than double and CO₂ emissions would virtually triple.

2 Product design

RESOURCE-SAVING

What does packaging need in order to be sustainable? What impact do its production, transport, and use have on the environment? Our designers don't get down to planning until all these questions have been answered. The packaging must be lightweight, yet strong enough to meet all requirements. It must also, if possible, be available in many different sizes to ensure a perfect fit for the products inside. The best example of this is our BlockPack. Furthermore - most of our packaging consists of only one type of plastic. We thus ensure that it can be recycled into high-quality materials at the end of its useful life.

3 Circle Up



RECYCLED MATERIAL

We have proven that plastic packaging and sustainability are not mutually exclusive - by developing our Circle Up packaging made from recycled material. For these products, we rely on the use of recycled material, which is for example made from plastic waste collected by private households. This plastic waste then undergoes professional processing and is transformed back into new, valuable resources - including our Circle Up packaging. "Closed-loop economy" is the magic word here. In other words: Through consistent recycling, the environmental problems associated with plastic waste can be effectively avoided.

4 Organic HDPE



PLANT-POWERED

We have been investigating alternative sources of raw materials for some time now. For example, we have successfully used sugar cane as a renewable raw material. Organic plastics do not consume finite fossil raw materials during their production. Instead, they are derived from renewable resources - and thus also make a significant contribution to reducing CO₂ emissions. These products have the same properties as their counterparts made of conventional plastic, i.e., they are just as strong and durable. We will certainly continue to take a close look at other alternatives in the future.



5 Certification



SIGNED AND SEALED

Since 2011, rose plastic AG has been certified in accordance with the ISO 14001 environmental management system and has signed up to the Bavarian Environmental Pact (Umweltpakt Bayern). In cooperation with our customer, the assembly and fastening experts Würth, we have developed recyclable packaging solutions for cutting tools made from 100% recycled material. These were finalists for the German Sustainability Award in the design category. We have also been awarded with the „Blue Angel“ environmental label by the Ministry of Health in Germany for our Products made from recycled material. After rigorous testing in the categories of material health, material reutilization, renewable energy management, water stewardship and social fairness, our protective packaging used for transport, storage and organization has been endorsed with the Cradle to Cradle® certificate in silver.



SUSTAINABILITY BROCHURE

Interested in learning more about our projects? Want to find out how we live up to our environmental responsibilities at rose plastic? Then we recommend taking a look at our sustainability brochure, which contains clear and concise summaries of all the relevant facts. www.rose-plastic.com



innovatio plastic pa

PRODUCT RANGE

Tubes



BlockPack	14
BlockPack TabletPunch	16
DIY-Pack for Forstner Drills	18
DIY-Pack rectangular	20
DIY-Pack round	22
TwistPack	24
ScrewPack	26
HexPack	28
HolidayBox	30
MH-Pack	32
MicroBox MB1	34
MicroBox Swing	36
MK-Pack	38
MultiPack	40
PlugPack	42
QuadroPack	44
RectangularPack	46
RoseSet	48
RoundDial-a-Tool	50
ChuckPack	52
SK-Pack CenterLock	54
SlimPack	56

SZ-PlugPack	58
TelePack	60
TopPack	62
TopPack Conical	66
TopPack FoldBack	68
TopPack Wing	70
TopPack XLine	72
TopPack XPress	74
TwistPack Plus	80
VarioBox	82
VarioPack NT	84
VarioPack VP and VPN	86

Boxes



BitPack	90
ConsumerBox	92
FivePack	94
InsertBox / InsertClickBox	96
InsertBox Connect	98
InsertBox HighS	100
InsertSplit Box	102
InsertSplit Box SL	104
MicroBox MB10	106

ns in ckaging



MicroBox MB50	108
MicroVario Box	109
DIY-Box	110
SplitPack	112
UniBox	114

Cases



MK-Case	122
RoseCase ErgoLine	124
RoseCase ProSecure	126
RoseCase ProTec	128
RoseCase RCB and RCS	132
RoseCassette	134
UniCase	136

Cassettes



FAcassette	140
FBcassette	144
FNKLcassette	146
FNSBcassette	148
GripBox	150
RoseBox	152

Transport & Storage systems



AQURADO®	158
LogisticBox	161
LogisticSystem	162
StorePack	164
SystemBoard	166
SZS-Stands	168

Hangers & Accessories



BlockPack Hanger	172
BlockPack EndCaps	173
DIY-Clips	174
ProtectiveCap	176
ProtectiveEndCaps PSC	178
Foam Inserts	180
Protective Sleeves	184
SDS-Clip	185
ToolHolder	186
TopPackFiveFrame	188

Our plastic packaging tubes

All-rounders and

Our packaging tubes offer optimum product protection as well as top quality sales and transport packaging for a wide variety of products. They stand out thanks to maximum product protection, high functionality, exemplary ergonomics, and appealing designs.



Screw Pack

Round plastic packaging tubes with fixed length and secure screw closure
more on page 26

Block Pack

Square telescopic plastic packaging tubes with TwistLock closure feature and ratchet length adjustment
more on page 14

Twist Pack Plus

More safety. More efficiency. The new generation of Twist-Pack packaging tubes convince with user-friendly "twist-lock" closure
more on page 80

proven specialists



Holiday Box

Clear plastic tube containers with carry-handle. Ideal packaging solution for retail and consumer products
more on page 30

TopPack XPress

Plastic packaging tubes with patented shankholding system. Ideal for precision shank tools
more on page 74

Quadro Pack

Square telescopic plastic packaging tubes with ratchet length adjustment
more on page 44



BlockPack

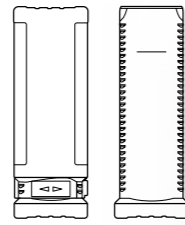

Square telescopic packaging tubes with twist lock closure feature and ratchet length adjustment

- highly secure bayonet-type twist lock closure, requires minimal force in opening and closing the pack
- contoured tube ends and lateral support grooves are integrated together to provide a cushioning effect
- with ratchet length adjustment
- ergonomic product design offers shape stability
- speedy handling
- excellent for stacking and storage
- durable and reusable
- sturdy, oil, and moisture resistant
- optional with hanger or end caps



The ultimate, universal packaging tube with telescopic length adjustment – for maximum product protection



PACKAGING

Outer parts and inner parts are packed separately in individual cartons



MATERIAL

- Polyethylene (PE)
- Polypropylene (PP)
- Polyvinylchloride (PVC)
- Recycled plastic
- Bio plastic



COLORS

- Depending on the material transparent, natural or in various attractive standard colors or two-color



ACCESSORIES

- Hanger (see page 172)
- EndCaps (see page 173)
- ToolHolder (see page 186)
- Foam inserts (see page 180)

USABLE LENGTHS

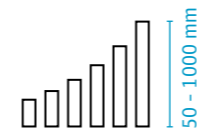

Ø DIAMETER

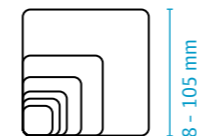

STANDARD COLORS



Product Range

Article	Ø	Usable length	PU	Article	Ø	Usable length	PU
BK 8 050	8mm	50 - 80mm	3000	BK 32 060	32mm	60 - 80mm	800
BK 8 080	8mm	80 - 120mm	3000	BK 32 080	32mm	80 - 120mm	600
BK 8 120	8mm	120 - 200mm	1500	BK 32 120	32mm	120 - 200mm	400
BK 8 200	8mm	200 - 350mm	2000	BK 32 200	32mm	200 - 350mm	360
BK 10 050	10mm	50 - 80mm	2100	BK 32 350	32mm	350 - 620mm	140
BK 10 080	10mm	80 - 120mm	2000	BK 35 050	35mm	50 - 70mm	900
BK 10 120	10mm	120 - 200mm	1170	BK 35 060	35mm	60 - 80mm	700
BK 10 200	10mm	200 - 350mm	1100	BK 35 080	35mm	80 - 120mm	500
BK 12 050	12mm	50 - 80mm	2200	BK 35 120	35mm	120 - 200mm	300
BK 12 080	12mm	80 - 120mm	1550	BK 35 200	35mm	200 - 350mm	300
BK 12 120	12mm	120 - 200mm	800	BK 35 350	35mm	350 - 620mm	159
BK 12 200	12mm	200 - 350mm	800	BK 40 080	40mm	80 - 120mm	450
BK 12 250	12mm	250 - 460mm	700	BK 40 120	40mm	120 - 200mm	300
BK 14 050	14mm	50 - 80mm	1700	BK 40 200	40mm	200 - 350mm	240
BK 14 080	14mm	80 - 120mm	1100	BK 40 350	40mm	350 - 620mm	120
BK 14 120	14mm	120 - 200mm	800	BK 45 060	45mm	60 - 80mm	450
BK 14 200	14mm	200 - 350mm	600	BK 45 080	45mm	80 - 120mm	350
BK 16 050	16mm	50 - 80mm	1600	BK 45 120	45mm	120 - 200mm	275
BK 16 080	16mm	80 - 120mm	850	BK 45 200	45mm	200 - 350mm	160
BK 16 120	16mm	120 - 200mm	1200	BK 45 350	45mm	350 - 620mm	90
BK 16 200	16mm	200 - 350mm	1200	BK 55 060	55mm	60 - 80mm	250
BK 18 050	18mm	50 - 80mm	1300	BK 55 080	55mm	80 - 120mm	200
BK 18 080	18mm	80 - 120mm	850	BK 55 120	55mm	120 - 200mm	200
BK 18 120	18mm	120 - 200mm	1050	BK 55 200	55mm	200 - 350mm	100
BK 18 200	18mm	200 - 350mm	400	BK 55 350	55mm	350 - 620mm	70
BK 20 050	20mm	50 - 80mm	1200	BK 65 080	65mm	80 - 120mm	210
BK 20 080	20mm	80 - 120mm	1300	BK 65 120	65mm	120 - 200mm	120
BK 20 120	20mm	120 - 200mm	900	BK 65 200	65mm	200 - 350mm	90
BK 20 200	20mm	200 - 350mm	800	BK 65 350	65mm	350 - 620mm	48
BK 20 350	20mm	350 - 620mm	500	BK 75 080	75mm	80 - 120mm	168
BK 22 050	22mm	50 - 80mm	1000	BK 75 120	75mm	120 - 200mm	96
BK 22 080	22mm	80 - 120mm	1200	BK 75 200	75mm	200 - 350mm	58
BK 22 120	22mm	120 - 200mm	800	BK 85 080	85mm	80 - 120mm	90
BK 22 200	22mm	200 - 350mm	600	BK 85 120	85mm	120 - 200mm	72
BK 24 050	24mm	50 - 80mm	750	BK 85 200	85mm	200 - 350mm	48
BK 24 080	24mm	80 - 120mm	1000	BK 85 350	85mm	350 - 620mm	30
BK 24 120	24mm	120 - 200mm	700	BK 85 550	85mm	550 - 1000mm	20
BK 24 200	24mm	200 - 350mm	550	BK 95 080	95mm	80 - 120mm	80
BK 26 050	26mm	50 - 60mm	700	BK 95 120	95mm	120 - 200mm	60
BK 26 060	26mm	60 - 80mm	700	BK 95 200	95mm	200 - 350mm	30
BK 26 080	26mm	80 - 120mm	850	BK 95 350	95mm	350 - 620mm	20
BK 26 120	26mm	120 - 200mm	600	BK 105 080	105mm	80 - 120mm	80
BK 26 200	26mm	200 - 350mm	450	BK 105 120	105mm	120 - 200mm	48
BK 26 350	26mm	350 - 620mm	288	BK 105 200	105mm	200 - 350mm	30
BK 32 050	32mm	50 - 70mm	1200	BK 105 350	105mm	350 - 620mm	20

Awards





BlockPack TabletPunch

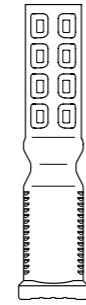

Packaging solution for tableting punches with twist lock closure feature

- the sensitive tip of the tableting punch is suspended for optimum protection
- highly secure bayonet-type twist lock closure, requires minimal force in opening and closing the pack
- contoured tube ends and lateral stiffening grooves provide protection for the punch
- ergonomic product design offers shape stability
- easy handling
- excellent for stacking and storage
- durable and reusable
- two sizes accommodate the most common tableting tool designs
- please note that rose plastic BlockPack TabletPunch must not be sold or resold in the UK



PACKAGING
Outer parts and inner parts are packed separately in individual cartons



MATERIAL

- Polyethylene (PE)
- Polyvinylchloride (PVC)
- Recycled plastic
- Bio plastic



COLORS

- Depending on the material transparent, natural or in various attractive standard colors or two-color

USABLE LENGTH



Ø DIAMETER

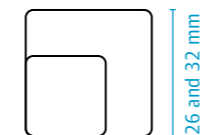

STANDARD COLORS



Product Range

Article	Inner diam.	Shank diam.	Usable length fix	PU
BKT 26 140 A+I	26mm	19.5mm	140mm	600
BKT 32 140 A+I	32mm	26mm	140mm	400

A = outer part; I = inner part

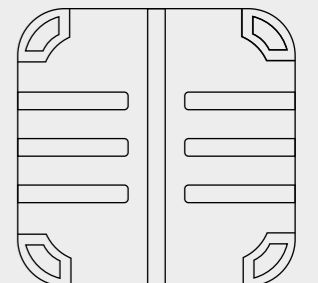
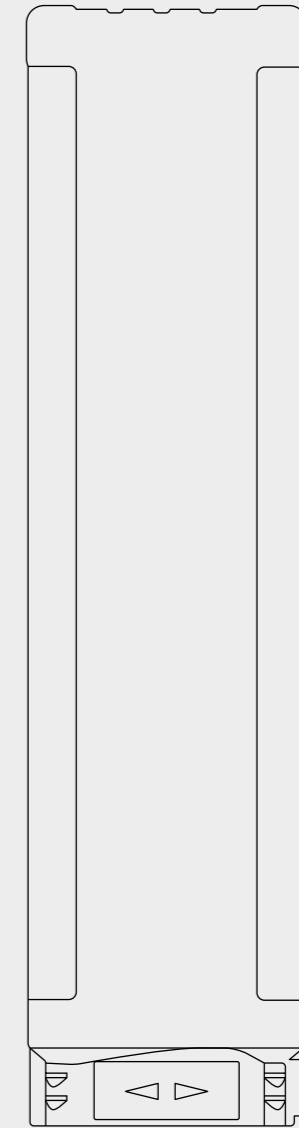
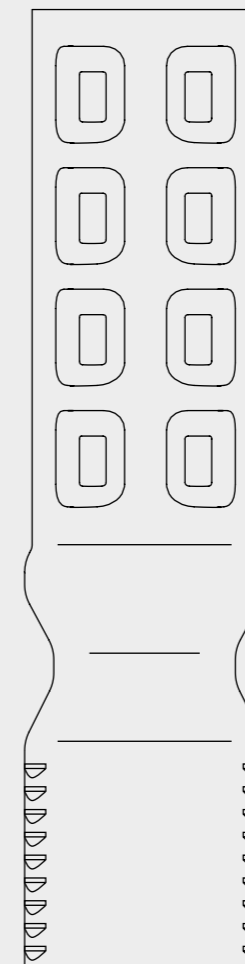

The perfect packaging solution for optimal protection of high-quality tableting punches

DIY-Pack for Forstner Drills

Plastic packaging and storage tubes for Forstner drills

- ideal for in-store display of Forstner drills
- tube bottom reinforced (cross shaped) for optimum protection
- ideal for product storage
- hanger plugs with euro hole or round hole; euro hanger plug available with or without labeling space

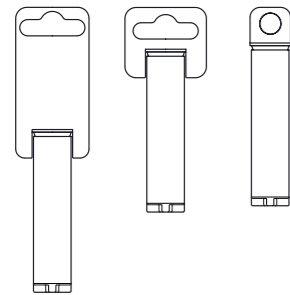

PACKAGING

Tubes and hangers are packed separately in individual cartons



MATERIAL

- Polypropylene (PP)



COLORS

- Tubes in transparent, hanger plugs in various attractive standard colors

USABLE LENGTH



Ø DIAMETER



STANDARD COLORS



Product Range

Tubes round

Article	Inner diam.	Inner length	PU
DYH 16 095/2	16mm	95mm	1800
DYH 22 095/2	22mm	95mm	1100
DYH 35 095/2	35mm	95mm	500
DYH 42 095/2	42mm	95mm	350

Hangers round

Article	Suitable for	Hanger	Hanger length	Hanger width	PU
DYT 15x18 10/1	DIY-Pack Ø 10	round hole hanger	18mm	15mm	12000
DYT 36x74 10/1	DIY-Pack Ø 10	euro hole hanger long	74mm	36mm	1500
DYT 40x34 10/1	DIY-Pack Ø 10	euro hole hanger short	34mm	40mm	4000
DYT 20x18 16/1	DIY-Pack Ø 16	round hole hanger	18mm	20mm	5000
DYT 36x74 16/1	DIY-Pack Ø 16	euro hole hanger long	74mm	36mm	2000
DYT 40x34 16/1	DIY-Pack Ø 16	euro hole hanger short	34mm	40mm	4000
DYT 26x18 22/1	DIY-Pack Ø 22	round hole hanger	18mm	26mm	3000
DYT 36x74 22/1	DIY-Pack Ø 22	euro hole hanger long	74mm	36mm	1500
DYT 40x34 22/1	DIY-Pack Ø 22	euro hole hanger short	34mm	40mm	3000
DYT 36x61 35/1	DIY-Pack Ø 35	euro hole hanger long	61mm	36mm	1000
DYT 39x17 35/1	DIY-Pack Ø 35	round hole hanger	17mm	39mm	1500
DYT 40x34 35/1	DIY-Pack Ø 35	euro hole hanger short	34mm	40mm	2000
DYT 36x61 42/1	DIY-Pack Ø 42	euro hole hanger long	61mm	36mm	900
DYT 40x34 42/1	DIY-Pack Ø 42	euro hole hanger short	34mm	40mm	1500
DYT 46x17 42/1	DIY-Pack Ø 42	round hole hanger	17mm	46mm	1500

Euro hole hanger long



Euro hole hanger short



Round hole hanger



The perfect solution to protect, present, and sell Forstner drills and artificial drills more effectively

PVC

DIY-Pack rectangular

Rectangular packaging and storage tubes for drills, chisels, sawblades and welding rods

- ideal for in-store product display
- one size label covers entire range
- lends itself to automated packaging
- reinforced tube bottom

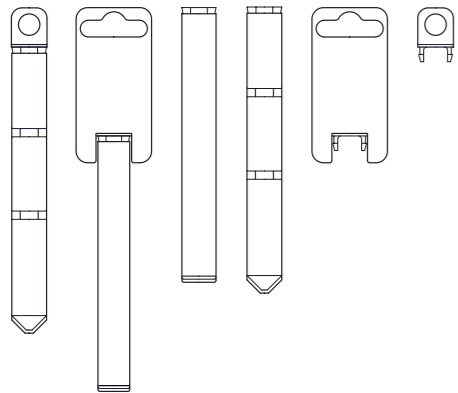

PACKAGING
Tubes and hangers are packed separately in individual cartons



MATERIAL
- Polypropylene (PP)



COLORS
- Tubes in transparent, hanger plugs in various attractive standard colors

USABLE LENGTHS

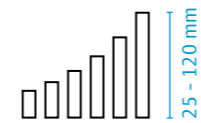

DIMENSION

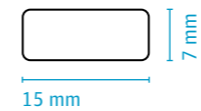

STANDARD COLORS



Product Range

Tubes rectangular

Article	Version	Description	Inner width	Inner height	Inner length	PU
DYR 7x15 025/1	1	plane version	7mm	15mm	25mm	5000
DYR 7x15 055/3	3	w/ feeder for bits	7mm	15mm	55mm	3000
DYR 7x15 080/1	1	plane version	7mm	15mm	80mm	2200
DYR 7x15 080/2	2	w/ feeder for drills	7mm	15mm	80mm	2200
DYR 7x15 110/1	1	plane version	7mm	15mm	110mm	1500
DYR 7x15 110/2	2	w/ feeder for drills	7mm	15mm	110mm	1500
DYR 7x15 120/1	1	plane version	7mm	15mm	120mm	1300
DYR 7x15 120/2	2	w/ feeder for drills	7mm	15mm	120mm	1300

Hangers rectangular

Article	Hanger	Hanger length	Hanger width	PU
DYE 17x18 7x15/1	round hole hanger	18mm	17mm	5000
DYE 36x74 7x15/1	euro hole hanger long	74mm	36mm	3000

Euro hole hanger long



Round hole hanger



Effective product protection, high-impact presentation of goods: This versatile DIY packaging is the highlight of any point of sale

DIY-Pack round

Round packaging and storage tubes for drills, chisels and welding rods

- ideal for in-store product display
- one size label covers entire range
- suitable for automated packaging
- reinforced tube bottom

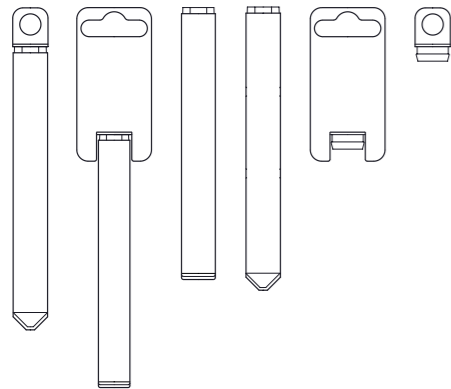

PACKAGING
Tubes and hangers are packed separately in individual cartons



MATERIAL
- Polypropylene (PP)



COLORS
- Tubes in transparent, hanger plugs in various attractive standard colors

USABLE LENGTHS

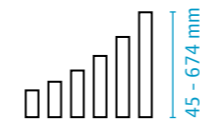

Ø DIAMETER

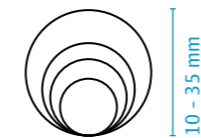

STANDARD COLORS



Product Range

Tubes round

Article	Version	Inner diam.	Length	PU	Article	Version	Inner diam.	Length	PU
DYH 10 085	1/3	10mm	89mm	2000	DYH 16 605	1/3	16mm	607mm	574
DYH 10 110	1/3	10mm	114mm	1700	DYH 16 640	1/3	16mm	642mm	578
DYH 10 125	1/3	10mm	129mm	2400	DYH 22 160	1/3	22mm	162mm	600
DYH 10 165	1/3	10mm	169mm	1700	DYH 22 200	1/3	22mm	204mm	750
DYH 10 220	1/3	10mm	224mm	1300	DYH 22 250	1/3	22mm	254mm	600
DYH 10 245	1/3	10mm	245mm	2300	DYH 22 300	1/3	22mm	304mm	530
DYH 10 270	1/3	10mm	274mm	2300	DYH 22 320	1/3	22mm	324mm	517
DYH 10 320	1/3	10mm	324mm	1000	DYH 22 355	1/3	22mm	355mm	470
DYH 16 045	1/3	16mm	45mm	2000	DYH 22 405	1	22mm	409mm	400
DYH 16 138	1/3	16mm	138mm	1100	DYH 22 440	1	22mm	444mm	350
DYH 16 155	1/3	16mm	157mm	900	DYH 22 470	1	22mm	474mm	350
DYH 16 160	1/3	16mm	162mm	1600	DYH 22 605	1	22mm	609mm	310
DYH 16 205	1/3	16mm	207mm	1300	DYH 22 640	1	22mm	644mm	440
DYH 16 255	1/3	16mm	257mm	1100	DYH 35 160	1/3	35mm	162mm	420
DYH 16 265	1/3	16mm	267mm	1100	DYH 35 250	1/3	35mm	254mm	280
DYH 16 305	1/3	16mm	307mm	920	DYH 35 320	1/3	35mm	324mm	200
DYH 16 320	1/3	16mm	322mm	900	DYH 35 355	3/3	35mm	355mm	200
DYH 16 410	1/3	16mm	412mm	680	DYH 35 470	1/3	35mm	474mm	180
DYH 16 445	1/3	16mm	447mm	630	DYH 35 605	1/3	35mm	609mm	153
DYH 16 475	1/3	16mm	477mm	610	DYH 35 670	1/3	35mm	674mm	165
DYH 16 510	1/3	16mm	512mm	525					

Version 1 = w/ tapered bottom; Version 3 = w/ flat bottom

DIY-Pack Tubes bulk

Article	Inner diam.	Inner length	Suitable for HSS drill-Ø	Drill packing qty. (pcs.)	PU
DYH 10 060/3	10mm	60mm	0.0 - 2.5mm	10	1800
DYH 16 078/3	16mm	78mm	3.0 - 4.2mm	10	2400
DYH 22 098/3	22mm	98mm	4.3 - 6.0mm	10	1200
DYH 35 122/3	35mm	122mm	6.1 - 8.5mm	10	400
DYH 35 156/3	35mm	156mm	10.5 - 13.0mm	5	218
DYH 42 138/3	42mm	138mm	8.6 - 10.0mm	10	250

Hangers round

Article	Suitable for	Hanger	Hanger length	Hanger width	PU
DYT 15x18 10/1	DIY-Pack Ø 10	round hole hanger	18mm	15mm	12000
DYT 36x74 10/1	DIY-Pack Ø 10	euro hole hanger long	74mm	36mm	1500
DYT 40x34 10/1	DIY-Pack Ø 10	euro hole hanger short	34mm	40mm	4000
DYT 20x18 16/1	DIY-Pack Ø 16	round hole hanger	18mm	20mm	5000
DYT 36x74 16/1	DIY-Pack Ø 16	euro hole hanger long	74mm	36mm	2000
DYT 40x34 16/1	DIY-Pack Ø 16	euro hole hanger short	34mm	40mm	4000
DYT 26x18 22/1	DIY-Pack Ø 22	round hole hanger	18mm	26mm	3000
DYT 36x74 22/1	DIY-Pack Ø 22	euro hole hanger long	74mm	36mm	1500
DYT 40x34 22/1	DIY-Pack Ø 22	euro hole hanger short	34mm	40mm	3000
DYT 36x61 35/1	DIY-Pack Ø 35	euro hole hanger long	61mm	36mm	1000
DYT 39x17 35/1	DIY-Pack Ø 35	round hole hanger	17mm	39mm	1500
DYT 40x34 35/1	DIY-Pack Ø 35	euro hole hanger short	34mm	40mm	2000
DYT 36x61 42/1	DIY-Pack Ø 42	euro hole hanger long	61mm	36mm	900
DYT 40x34 42/1	DIY-Pack Ø 42	euro hole hanger short	34mm	40mm	1500
DYT 46x17 42/1	DIY-Pack Ø 42	round hole hanger	17mm	46mm	1500



The perfect packaging for optimum protection and effective presentation of your product



TwistPack

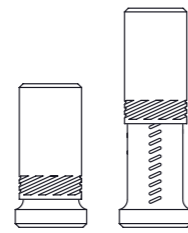

Round telescopic plastic packaging tubes with twist lock mechanism and roll-away protection

- twist lock mechanism holds contents securely in place
- infinitely variable telescopic length adjustment
- hexagon tube bottom prevents rolling
- durable and reusable
- rigid, humidity and oil resistant



As one of the world's best-selling packaging tubes, the TwistPack excels thanks to practical features and almost limitless applications



PACKAGING

Outer parts and inner parts are packed separately in individual cartons;
 DP 65 350, DP 80 and DP 105 outer parts and inner parts are packed assembled



MATERIAL

- Polyethylene (PE)
- Polypropylene (PP)
- Polyvinylchloride (PVC)
- Recycled plastic
- Bio plastic



COLORS

- Depending on the material transparent, natural or in various attractive standard colors or two-color



ACCESSORIES

- With hanger on request
- Foam Inserts (see page 180)

USABLE LENGTHS

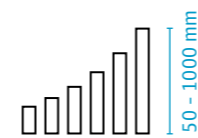

Ø DIAMETER



STANDARD COLORS



Product Range

Article	Inner diam.	Usable length	PU	Article	Inner diam.	Usable length	PU
DP 10 050	10mm	50 - 70mm	2100	DP 35 080	35mm	80 - 120mm	600
DP 10 080	10mm	80 - 120mm	2000	DP 35 120	35mm	120 - 200mm	400
DP 10 120	10mm	120 - 200mm	2100	DP 35 200	35mm	200 - 350mm	310
DP 13 050	13mm	50 - 70mm	2200	DP 35 350	35mm	350 - 620mm	180
DP 13 080	13mm	80 - 120mm	1300	DP 40 050	40mm	50 - 60mm	350
DP 13 120	13mm	120 - 200mm	1600	DP 40 060	40mm	60 - 80mm	350
DP 13 200	13mm	200 - 350mm	1500	DP 40 080	40mm	80 - 120mm	500
DP 16 050	16mm	50 - 70mm	1700	DP 40 120	40mm	120 - 200mm	300
DP 16 080	16mm	80 - 120mm	1000	DP 40 200	40mm	200 - 350mm	250
DP 16 120	16mm	120 - 200mm	1200	DP 40 250	40mm	250 - 400mm	210
DP 16 200	16mm	200 - 350mm	1000	DP 40 350	40mm	350 - 620mm	150
DP 16 350	16mm	350 - 620mm	600	DP 45 050	45mm	50 - 60mm	350
DP 16 410	16mm	410 - 770mm	500	DP 45 060	45mm	60 - 80mm	600
DP 20 050	20mm	50 - 70mm	1500	DP 45 080	45mm	80 - 120mm	400
DP 20 080	20mm	80 - 120mm	1700	DP 45 120	45mm	120 - 200mm	250
DP 20 120	20mm	120 - 200mm	1000	DP 45 200	45mm	200 - 350mm	200
DP 20 200	20mm	200 - 350mm	900	DP 45 350	45mm	350 - 620mm	115
DP 22 050	22mm	50 - 60mm	1100	DP 50 050	50mm	50 - 60mm	600
DP 22 080	22mm	80 - 120mm	1400	DP 50 060	50mm	60 - 80mm	500
DP 22 120	22mm	120 - 200mm	850	DP 50 080	50mm	80 - 120mm	330
DP 22 200	22mm	200 - 350mm	700	DP 50 120	50mm	120 - 200mm	220
DP 22 350	22mm	350 - 620mm	390	DP 50 200	50mm	200 - 350mm	150
DP 22 410	22mm	410 - 770mm	300	DP 50 350	50mm	350 - 620mm	95
DP 24 050	24mm	50 - 60mm	900	DP 55 050	55mm	50 - 60mm	500
DP 24 080	24mm	80 - 120mm	1100	DP 55 060	55mm	60 - 80mm	400
DP 24 120	24mm	120 - 200mm	750	DP 55 080	55mm	80 - 120mm	300
DP 24 200	24mm	200 - 350mm	600	DP 55 120	55mm	120 - 200mm	190
DP 26 050	26mm	50 - 60mm	800	DP 55 200	55mm	200 - 350mm	135
DP 26 080	26mm	80 - 120mm	1000	DP 55 350	55mm	350 - 620mm	70
DP 26 120	26mm	120 - 200mm	600	DP 65 050	65mm	50 - 60mm	350
DP 26 200	26mm	200 - 350mm	450	DP 65 060	65mm	60 - 80mm	300
DP 26 250	26mm	250 - 400mm	420	DP 65 080	65mm	80 - 120mm	220
DP 26 350	26mm	350 - 620mm	280	DP 65 120	65mm	120 - 200mm	150
DP 26 410	26mm	410 - 770mm	240	DP 65 200	65mm	200 - 350mm	96
DP 28 050	28mm	50 - 60mm	800	DP 65 350	65mm	350 - 620mm	46
DP 28 080	28mm	80 - 120mm	950	DP 80 060	85mm	60 - 80mm	100
DP 28 120	28mm	120 - 200mm	600	DP 80 080	85mm	80 - 100mm	108
DP 28 200	28mm	200 - 350mm	450	DP 80 120	85mm	120 - 180mm	72
DP 30 050	30mm	50 - 60mm	700	DP 80 200	85mm	200 - 350mm	50
DP 30 080	30mm	80 - 120mm	800	DP 80 350	85mm	350 - 550mm	18
DP 30 120	30mm	120 - 200mm	500	DP 80 550	85mm	550 - 1000mm	18
DP 30 200	30mm	200 - 350mm	400	DP 105 080	105mm	80 - 100mm	72
DP 30 350	30mm	350 - 620mm	230	DP 105 120	105mm	120 - 180mm	52
DP 30 410	30mm	410 - 770mm	200	DP 105 200	105mm	200 - 350mm	30
DP 35 050	35mm	50 - 60mm	500				
DP 35 060	35mm	60 - 80mm	900				

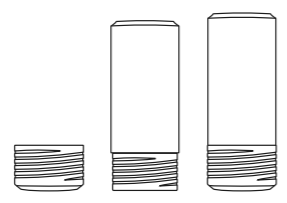

ScrewPack

Round plastic packaging tubes with fixed length and secure screw closure

- length is produced to customer requirements
- thread is positioned to customer requirements
- durable and reusable
- sturdy, oil, and moisture resistant



PACKAGING

Outer parts and inner parts are packed separately in individual cartons



MATERIAL

- Polyethylene (PE)
- Polypropylene (PP)
- Polyvinylchloride (PVC)
- Recycled plastic
- Bio plastic



COLORS

- Depending on the material transparent, natural or in various attractive standard colors or two-color



ACCESSORIES

- With hanger on request
- Foam Inserts (see page 180)

USABLE LENGTHS

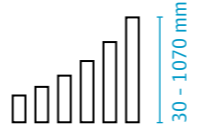

Ø DIAMETER



STANDARD COLORS



Product Range

ScrewPack Tubes

Article	Inner diam.	Length outer part min.- max.	Length inner part min.- max.	Total usable length
GP 25	28mm	25-407mm	5-387mm	794mm
GP 35	37mm	25-407mm	5-387mm	794mm
GP 40	41mm	35-390mm	5-360mm	750mm
GP 45	46mm	35-715mm	5-685mm	1400mm
GP 55	56mm	35-575mm	5-545mm	1020mm
GP 65	66mm	45-520mm	5-480mm	1000mm
GP 75	76mm	55-525mm	5-480mm	1005mm
GP 80	79mm	55-540mm	5-490mm	1030mm
GP 85	85mm	55mm	35mm	90mm
GP 90	91mm	55-485mm	5-436mm	921mm
GP 100	98mm	55-540mm	5-490mm	1030mm
GP 105	107mm	55-540mm	5-490mm	1030mm
GP 125	125mm	70-585mm	10-525mm	1110mm
GP 160	160mm	110-575mm	30-495mm	1070mm

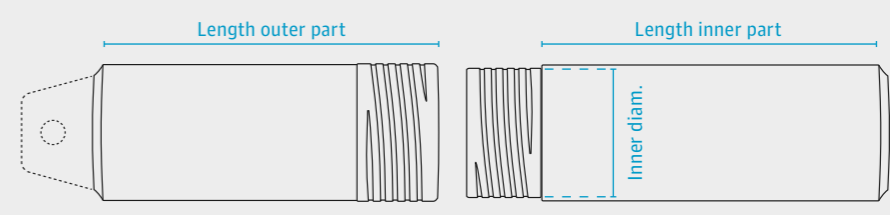

ScrewPack Postal Tubes

Article	Format	Inner diam.	Inner length	Weight (g/psc.)	PU	Article	Format	Inner diam.	Inner length	Weight (g/psc.)	PU
GP 45 220 K	DIN A4	45	220	32	170	GP 45 620 K	DIN A1	45	620	80	58
GP 55 220 K	DIN A4	55	220	40	110	GP 55 620 K	DIN A1	55	620	100	40
GP 65 220 K	DIN A4	65	220	51	82	GP 65 620 K	DIN A1	65	620	132	28
GP 80 220 K	DIN A4	80	220	75	56	GP 80 620 K	DIN A1	80	620	162	20
GP 100 220 K	DIN A4	100	220	108	36	GP 100 620 K	DIN A1	100	620	268	11
GP 45 320 K	DIN A3	45	320	50	121	GP 65 880 K	DIN A0	65	880	185	20
GP 55 320 K	DIN A3	55	320	53	81	GP 80 880 K	DIN A0	80	880	215	14
GP 65 320 K	DIN A3	65	320	80	56	GP 100 880 K	DIN A0	100	880	330	9
GP 80 320 K	DIN A3	80	320	108	40	GP 45 1000 K	*	45	1000	124	20
GP 100 320 K	DIN A3	100	320	145	24	GP 55 1120 K	*	55	1120	210	14
GP 45 440 K	DIN A2	45	440	58	85	GP 65 800 K	*	65	800	162	9
GP 55 440 K	DIN A2	55	440	72	56	GP 80 800 K	*	80	800	212	70
GP 65 440 K	DIN A2	65	440	110	40	GP 100 800 K	*	100	800	340	45
GP 80 440 K	DIN A2	80	440	136	28						
GP 100 440 K	DIN A2	100	440	184	18						

*Special length

ScrewPack SetPack

Article	Innerdiameter	Usable length fix	PU
GP 65 080 S	66	90	150
GP 65 100 S	66	110	150
GP 65 110 S	66	120	150

Are you looking for a solid, economical, and versatile packaging tube? You've just found it...



HexPack

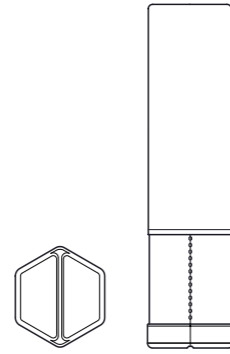

Hexagonal telescopic plastic packaging tubes with ratchet length adjustment. Ideal for drills, milling cutters, shank tools, tool holders and tool bits

- infinitely variable telescopic length adjustment
- speedy efficient packaging
- speedy handling
- excellent for stacking and storage
- durable and reusable
- sturdy, oil, and moisture resistant



The practical packaging tube with a honeycomb design offers excellent product protection and easy telescopic length adjustment



PACKAGING

Outer parts and inner parts are packed separately in individual cartons



MATERIAL

- Polyethylene (PE)
- Polypropylene (PP)
- Polyvinylchloride (PVC)
- Recycled plastic
- Bio plastic



COLORS

- Depending on the material transparent, natural or in various attractive standard colors or two-color



ACCESSORIES

- With hanger on request

USABLE LENGTHS

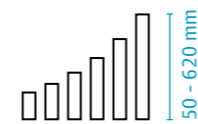

Ø DIAMETER



STANDARD COLORS



Product Range

Article	Inner diameter	Usable length adjustable	PU
SW 13 050	13mm	50 - 80mm	2500
SW 13 080	13mm	80 - 120mm	2000
SW 13 120	13mm	120 - 200mm	1700
SW 16 050	16mm	50 - 80mm	1700
SW 16 080	16mm	80 - 120mm	1000
SW 16 120	16mm	120 - 200mm	1000
SW 16 200	16mm	200 - 350mm	2000
SW 16 350	16mm	350 - 620mm	700
SW 20 050	20mm	50 - 80mm	1000
SW 20 080	20mm	80 - 120mm	1400
SW 20 120	20mm	120 - 200mm	1000
SW 20 200	20mm	200 - 350mm	760
SW 20 350	20mm	350 - 620mm	500
SW 26 060	26mm	60 - 80mm	1300
SW 26 080	26mm	80 - 120mm	1000
SW 26 120	26mm	120 - 200mm	550
SW 26 200	26mm	200 - 350mm	580
SW 26 350	26mm	350 - 620mm	250
SW 32 060	32mm	60 - 80mm	900
SW 32 080	32mm	80 - 120mm	650
SW 32 120	32mm	120 - 200mm	400
SW 32 200	32mm	200 - 350mm	350
SW 32 350	32mm	350 - 620mm	220
SW 38 060	38mm	60 - 80mm	650
SW 38 080	38mm	80 - 120mm	500
SW 38 120	38mm	120 - 200mm	300
SW 38 200	38mm	200 - 350mm	270
SW 38 350	38mm	350 - 620mm	150
SW 45 060	45mm	60 - 80mm	400
SW 45 080	45mm	80 - 120mm	300
SW 45 120	45mm	120 - 200mm	220
SW 45 200	45mm	200 - 350mm	186
SW 45 350	45mm	350 - 620mm	106
SW 55 060	55mm	60 - 80mm	270
SW 55 080	55mm	80 - 120mm	240
SW 55 120	55mm	120 - 200mm	220
SW 55 200	55mm	200 - 350mm	134
SW 55 350	55mm	350 - 620mm	64
SW 65 080	65mm	80 - 120mm	180
SW 65 120	65mm	120 - 200mm	155
SW 65 200	65mm	200 - 350mm	84

Holiday Box

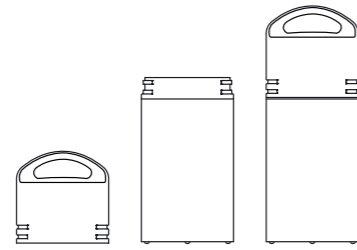

Clear plastic tube containers with carry-handle. Ideal packaging solution for retail and consumer products

- highly transparent material combined with short perimeter thread provides perfect product display
- practical closure mechanism: simple, quick and secure
- variable inner length allows packaging to be sized exactly to the product
- universal application
- fixed length outers with handy, attractively shaped carry-handle
- numerous secondary uses



This packaging tube is a true jack-of-all-trades: The highly transparent PVC makes it ideal as sales packaging as well as a useful tool to store anything you can think of



PACKAGING
Outer parts and inner parts are packed separately in individual cartons



MATERIAL
- Polyvinylchloride (PVC)



COLORS
- PVC clear or in various attractive standard colors

USABLE LENGTHS

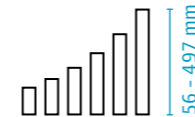

Ø DIAMETER

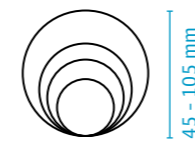

STANDARD COLORS



Product Range

Article	Inner diam.	Usable length	PU	Article	Inner diam.	Usable length	PU
HB 45 025/2	45mm	56mm	1000	HB 65 225/2	65mm	270mm	1000
HB 45 050/2	45mm	81mm	1000	HB 65 250/2	65mm	295mm	1000
HB 45 075/2	45mm	106mm	1000	HB 65 275/2	65mm	320mm	1000
HB 45 100/2	45mm	131mm	1000	HB 65 300/2	65mm	345mm	1000
HB 45 125/2	45mm	156mm	1000	HB 65 325/2	65mm	370mm	1000
HB 45 150/2	45mm	181mm	1000	HB 65 350/2	65mm	395mm	1000
HB 45 175/2	45mm	206mm	1000	HB 65 375/2	65mm	420mm	1000
HB 45 200/2	45mm	231mm	1000	HB 65 400/2	65mm	445mm	1000
HB 45 225/2	45mm	256mm	1000	HB 65 425/2	65mm	470mm	1000
HB 45 250/2	45mm	281mm	1000	HB 65 450/2	65mm	495mm	1000
HB 45 275/2	45mm	306mm	1000	HB 85 040/2	85mm	94mm	1000
HB 45 300/2	45mm	331mm	1000	HB 85 050/2	85mm	104mm	1000
HB 45 325/2	45mm	356mm	1000	HB 85 075/2	85mm	129mm	1000
HB 45 350/2	45mm	381mm	1000	HB 85 100/2	85mm	154mm	1000
HB 45 375/2	45mm	406mm	1000	HB 85 125/2	85mm	179mm	1000
HB 45 400/2	45mm	431mm	1000	HB 85 150/2	85mm	204mm	1000
HB 45 425/2	45mm	456mm	1000	HB 85 175/2	85mm	229mm	1000
HB 45 450/2	45mm	481mm	1000	HB 85 200/2	85mm	254mm	1000
HB 45 466/2	45mm	497mm	1000	HB 85 225/2	85mm	279mm	1000
HB 55 030/2	55mm	68mm	1000	HB 85 250/2	85mm	304mm	1000
HB 55 050/2	55mm	88mm	1000	HB 85 275/2	85mm	329mm	1000
HB 55 075/2	55mm	113mm	1000	HB 85 300/2	85mm	354mm	1000
HB 55 100/2	55mm	138mm	1000	HB 85 325/2	85mm	379mm	1000
HB 55 125/2	55mm	163mm	1000	HB 85 350/2	85mm	404mm	1000
HB 55 150/2	55mm	188mm	1000	HB 85 375/2	85mm	429mm	1000
HB 55 175/2	55mm	213mm	1000	HB 85 400/2	85mm	454mm	1000
HB 55 200/2	55mm	238mm	1000	HB 85 425/2	85mm	479mm	1000
HB 55 225/2	55mm	263mm	1000	HB 85 440/2	85mm	494mm	1000
HB 55 250/2	55mm	288mm	1000	HB 105 050/2	105mm	113mm	1000
HB 55 275/2	55mm	313mm	1000	HB 105 075/2	105mm	138mm	1000
HB 55 300/2	55mm	338mm	1000	HB 105 100/2	105mm	163mm	1000
HB 55 325/2	55mm	363mm	1000	HB 105 125/2	105mm	188mm	1000
HB 55 350/2	55mm	388mm	1000	HB 105 150/2	105mm	213mm	1000
HB 55 375/2	55mm	413mm	1000	HB 105 175/2	105mm	238mm	1000
HB 55 400/2	55mm	438mm	1000	HB 105 200/2	105mm	263mm	1000
HB 55 425/2	55mm	463mm	1000	HB 105 225/2	105mm	288mm	1000
HB 55 450/2	55mm	488mm	1000	HB 105 250/2	105mm	313mm	1000
HB 55 458/2	55mm	496mm	1000	HB 105 275/2	105mm	338mm	1000
HB 65 030/2	65mm	75mm	1000	HB 105 300/2	105mm	363mm	1000
HB 65 050/2	65mm	95mm	1000	HB 105 325/2	105mm	388mm	1000
HB 65 075/2	65mm	120mm	1000	HB 105 350/2	105mm	413mm	1000
HB 65 100/2	65mm	145mm	1000	HB 105 375/2	105mm	438mm	1000
HB 65 125/2	65mm	170mm	1000	HB 105 400/2	105mm	463mm	1000
HB 65 150/2	65mm	195mm	1000	HB 105 425/2	105mm	488mm	1000
HB 65 175/2	65mm	220mm	1000	HB 105 430/2	105mm	493mm	1000
HB 65 200/2	65mm	245mm	1000				

MH-Pack

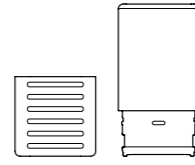

High-quality, stable packaging tube for the manufacturer and end user of modular milling heads

- perfect protection of sharpened and delicate milling heads
- efficient packing, secure and easy removal
- simple handling; easy to open and close due to incorporated grooves in the base
- the cap ensures injury-free and damage-free clamping of the tool changing head
- clamping strips for wrench size and shaft diameter provide a tight fit for the milling head
- perfect presentation of tool
- packaging can be labeled and sealed
- durable and reusable
- sturdy, oil, and moisture resistant



PACKAGING
Base and cover are packed separately in individual cartons



MATERIAL
- Base made from impact resistant ABS
- Cover in Polypropylene (PP)



COLORS
- Cover in transparent
- Base in gray or in various attractive standard colors

HEAD LENGTHS

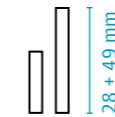

CUTTING EDGE DIAM.

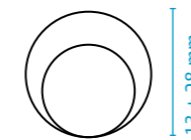

STANDARD COLORS



Product Range

Article	Part type	Wrench size SW	Shank diam.	max. cutting edge diam.	max. head length LM4	PU
MH 18x21/1 B	base					500
MH 18x4-8/1 C	cover	4mm	6 - 8mm	13mm	28mm	500
MH 18x4-10/1 C	cover	4mm	8 - 10mm	13mm	28mm	500
MH 18x5.5-10/1 C	cover	5.5mm	8 - 10mm	13mm	28mm	500
MH 18x5.5-12/1 C	cover	5.5mm	10 - 12mm	13mm	28mm	500
MH 18x6.5-13/1 C	cover	6.5mm	11 - 13mm	13mm	28mm	500
MH 18x6-8/1 C	cover	6mm	6 - 8mm	13mm	28mm	500
MH 18x6-10/1 C	cover	6mm	8 - 10mm	13mm	28mm	500
MH 18x8-10/1 C	cover	8mm	8 - 10mm	13mm	28mm	500
MH 18x8-12/1 C	cover	8mm	10 - 12mm	13mm	28mm	500
MH 18x10-12/1 C	cover	10mm	10 - 12mm	13mm	28mm	500
MH 36x35/1 B	base					350
MH 36x6.5-16/1 C	cover	6.5mm	14 - 16mm	28mm	49mm	350
MH 36x7.7-16/1 C	cover	7.7mm	14 - 16mm	28mm	49mm	350
MH 36x8-16/1 C	cover	8mm	14 - 16mm	28mm	49mm	350
MH 36x9-20/1 C	cover	9mm	18 - 20mm	28mm	49mm	350
MH 36x10-13/1 C	cover	10mm	11 - 13mm	28mm	49mm	350
MH 36x12-16/1 C	cover	12mm	14 - 16mm	28mm	49mm	350
MH 36x13-16/1 C	cover	13mm	14 - 16mm	28mm	49mm	350
MH 36x16-20/1 C	cover	16mm	18 - 20mm	28mm	49mm	350
MH 36x20-25/1 C	cover	20mm	23 - 25mm	28mm	49mm	350
MH 36x21-25/1 C	cover	21mm	23 - 25mm	28mm	49mm	350

Awards



MicroBox MB1

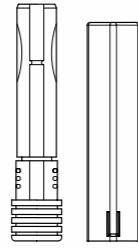

Packaging tubes for sensitive micro drills, precision drills, precision milling cutters and PCB drills

- optimum protection of tools thanks to complete coating of tool by back and outer part of packaging
- groove in bottom part makes opening easy
- fold back feature allows safe, secure removal of tool; available with or without shaft clamping device



PACKAGING
Outer parts and inner parts are packed separately in individual cartons



MATERIAL
- Polypropylene (PP)



COLORS
- Outer part in transparent; inner part in various attractive standard colors

USABLE LENGTHS

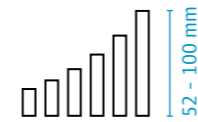

SHANK DIAM.

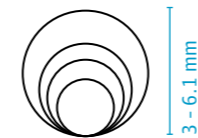

STANDARD COLORS



Product Range

Inner part

Article	Part type	Version	Shank diam.	Shank diam. (in.)	Clamping in base	Length stop at	PU
MB 1 3/1 I	inner part	1	3mm		Yes	-	1000
MB 1 3.175/1 I	inner part	1	3.175mm	1/8"	Yes	-	1000
MB 1 3.175/2 I	inner part	2	3.175mm	1/8"	No	34mm	1000
MB 1 3.175/3 I	inner part	3	3.175mm	1/8"	Yes	34mm	1000
MB 1 3.175/4 I	inner part	4	3.175mm	1/8"	No	27mm	1000
MB 1 3-6/1 I	inner part	1	3-6mm		Yes	-	400
MB 1 3-6/2 I	inner part	2	3-6mm		Yes	55mm	400
MB 1 3-6/3 I	inner part	3	3-6mm		Yes	75mm	400
MB 1 3-6/5 I	inner part	5	3-6mm		Yes	46mm	400
MB 1 3-6/4 I	inner part	4	3-6mm		Yes	36mm	400
MB 1 3-6/6 I*	inner part	6	3-6.1mm		Yes	46mm	400

Version 1 without length stop. Versions 2-6 with length stop.

*Rear panel not foldable.

Outer part

Article	Part type	∅	Inner length	Suitable for	Usable length	PU
TPK 8x52 A	outer part	8mm	52mm	MB 1 /3 + MB 1 /3.175	52mm	1000
TPK 8x70 A	outer part	8mm	70mm	MB 1 /3 + MB 1 /3.175	68mm	1000
TPK 13x74 A	outer part	13mm	74mm	MB 1 /3-6	74mm	500
TPK 13x97 A	outer part	13mm	97mm	MB 1 /3-6	100mm	500

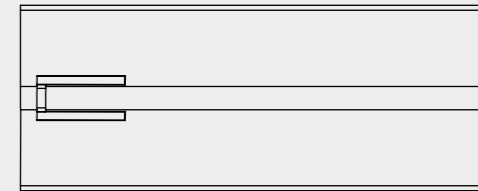
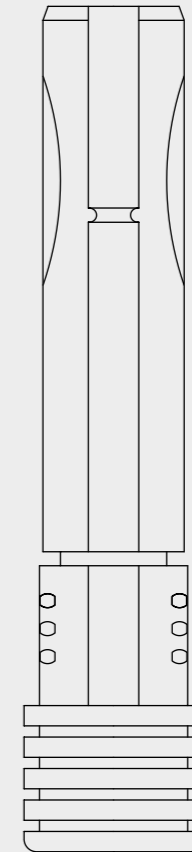



Small yet perfectly proportioned: the ideal packaging for micro drills and precision milling cutters

MicroBox Swing

High-quality plastic packaging tubes for sensitive solid carbide micro tools and premium shank tools

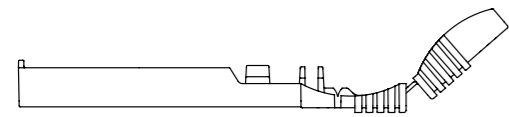
- optimum protection of tools
 - easy loading and unloading of tools
 - the tool can be extracted easily by pressing on the shank end of the pack
 - flexible hinges on the inner part expose the tool shank socket
 - an enlarged opening angle of 270° allows for non-contact removal and direct attachment of the tool to the desired machine
 - tools are tightly secured by the clamping mechanism in the fold back design. Additional clamping is available by adding a soft layer of material to the clamping
- area to secure highly polished and smooth tool shanks
 - durable hinge design creates reusability of the package
 - coding by different color versions of the "PLUS" clamping device possible
 - optimum visibility of content
 - sturdy, oil, and moisture resistant



 **Maximum grip and easy handling. The ideal protective packaging for micro tools**



PACKAGING

Outer parts and inner parts are packed separately in individual cartons



MATERIAL

- Inner part: Polypropylene (PP)
- Inner part with "PLUS" clamping device: Polypropylen (PP) with TPE
- Outer part: Polypropylene (PP)



COLORS

- Outer parts and inner parts in transparent
- "PLUS" clamping device in natural
- Further colors and color combinations on request

LENGTHS

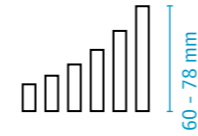

SHANK DIAM.

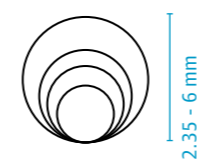

STANDARD COLORS



Product Range

Inner part

Article	Part type	Ø	Shank diam.	PU
MBS 8x52-2.35/1 I	inner part	8mm	2.35mm	1000
MBS 8x52-3/1 I	inner part	8mm	3mm	1000
MBS 8x52-4/1 I	inner part	8mm	4mm	1000
MBS 8x52-6/1 I	inner part	8mm	6mm	1000
MBS 8x52-2.35/2 PLUS I	inner part w/ PLUS clamping	8mm	2.35mm	1000
MBS 8x52-3/2 PLUS I	inner part w/ PLUS clamping	8mm	3mm	1000
MBS 8x52-4/2 PLUS I	inner part w/ PLUS clamping	8mm	4mm	1000
MBS 8x52-6/2 PLUS I	inner part w/ PLUS clamping	8mm	6mm	1000
MBS 8x70-2.35/1 I	inner part	8mm	2.35mm	1000
MBS 8x70-3/1 I	inner part	8mm	3mm	1000
MBS 8x70-4/1 I	inner part	8mm	4mm	1000
MBS 8x70-6/1 I	inner part	8mm	6mm	1000
MBS 8x70-2.35/2 PLUS I	inner part w/ PLUS clamping	8mm	2.35mm	1000
MBS 8x70-3/2 PLUS I	inner part w/ PLUS clamping	8mm	3mm	1000
MBS 8x70-4/2 PLUS I	inner part w/ PLUS clamping	8mm	4mm	1000
MBS 8x70-6/2 PLUS I	inner part w/ PLUS clamping	8mm	6mm	1000

Outer part

Article	Part type	Ø	Inner length	Suitable for	Usable length	PU
TPK 8x52 A	outer part	8mm	52mm	MBS 8x52	60mm	1000
TPK 8x70 A	outer part	8mm	70mm	MBS 8x70	78mm	1000

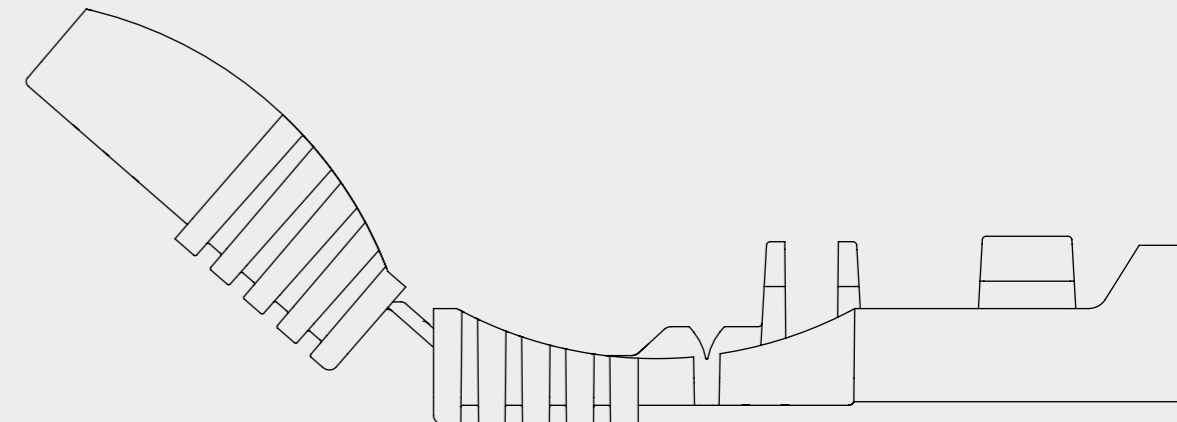



MK-Pack

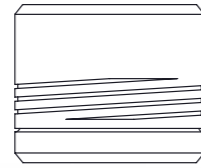

Packaging and storage tubes for face milling cutters and shell end mills

- with secure twist closure
- tool is secured in the center of the pack by means of a spigot located in the tool arbor hole
- adaptor rings to accommodate various arbor hole sizes (to be plugged into the spigot insert)
- foam insert to be put into cover of pack for additional protection available
- easy handling
- durable and reusable
- sturdy, oil, and moisture resistant



Simple, safe, and solid.
No other packaging tube offers as much protection for heavyweights



PACKAGING
Outer parts and inner parts are packed assembled



MATERIAL

- Polyethylene (PE)
- Recycled plastic
- Bio plastic



COLORS

- Depending on the material natural or in various attractive standard



ACCESSORIES

- Center spigot insert
- Adapter ring
- Foam inserts (see page 180)

USABLE LENGTHS

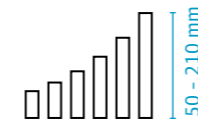

Ø DIAMETER

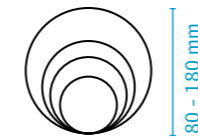

STANDARD COLORS



Product Range

MK-Pack

Article	Ø	Usable length	PU	Article	Ø	Usable length	PU
MK 80 050	80mm	50 - 60mm	170	MK 125 170	125mm	170 - 180mm	24
MK 80 070	80mm	70 - 80mm	120	MK 125 200	125mm	200 - 210mm	20
MK 80 090	80mm	90 - 100mm	100	MK 150 065	150mm	65 - 75mm	42
MK 80 110	80mm	110 - 120mm	80	MK 150 075	150mm	75 - 85mm	36
MK 80 130	80mm	130 - 140mm	80	MK 150 090	150mm	90 - 100mm	30
MK 100 060	100mm	60 - 70mm	95	MK 150 110	150mm	110 - 120mm	24
MK 100 070	100mm	70 - 80mm	70	MK 150 130	150mm	130 - 140mm	24
MK 100 090	100mm	90 - 100mm	65	MK 150 150	150mm	150 - 160mm	20
MK 100 110	100mm	110 - 120mm	60	MK 150 170	150mm	170 - 180mm	18
MK 100 130	100mm	130 - 140mm	50	MK 150 200	150mm	200 - 210mm	12
MK 100 150	100mm	150 - 160mm	45	MK 180 065	180mm	65 - 75mm	30
MK 100 170	100mm	170 - 180mm	39	MK 180 075	180mm	75 - 85mm	24
MK 100 200	100mm	200 - 210mm	32	MK 180 090	180mm	90 - 100mm	24
MK 125 065	125mm	65 - 75mm	56	MK 180 110	180mm	110 - 120mm	18
MK 125 075	125mm	75 - 85mm	50	MK 180 130	180mm	130 - 140mm	15
MK 125 090	125mm	90 - 100mm	40	MK 180 150	180mm	150 - 160mm	12
MK 125 110	125mm	110 - 120mm	35	MK 180 170	180mm	170 - 180mm	10
MK 125 130	125mm	130 - 140mm	30	MK 180 200	180mm	200 - 210mm	12
MK 125 150	125mm	150 - 160mm	25				

MK-Pack accessories

Article	Description	Suitable for	Shank diam.	Shank diam. (in.)	Outer height	PU
Ring 25.4/22 (1)	adapter ring inch	ST 80/22, ST 100/22, ST 125/22, ST 150/22	25.4mm	1		2000
Ring 31.75/22 (1.25)	adapter ring inch	ST 80/22, ST 100/22, ST 125/22, ST 150/22	31.75mm	1 1/4		1500
Ring 38.1/22 (1.5)	adapter ring inch	ST 80/22, ST 100/22, ST 125/22, ST 150/22	38.1mm	1 1/2		1500
Ring 50.8/40 (2)	adapter ring inch	ST 180/40	50.8mm	2		1000
Ring RG 27/22	adapter ring metric	ST 80/22, ST 100/22, ST 125/22, ST 150/22	27mm			2000
Ring RG 30/22	adapter ring metric	ST 80/22, ST 100/22, ST 125/22, ST 150/22	30mm			1500
Ring RG 32/22	adapter ring metric	ST 80/22, ST 100/22, ST 125/22, ST 150/22	32mm			1500
Ring RG 40/22	adapter ring metric	ST 80/22, ST 100/22, ST 125/22, ST 150/22	40mm			1000
ST 80/22	center spigot insert	MK 80	22mm		20mm	300
ST 100/22	center spigot insert	MK 100	22mm		20mm	200
ST 125/22	center spigot insert	MK 125	22mm		20mm	120
ST 150/22	center spigot insert	MK 150	22mm		20mm	100
ST 180/38.1	center spigot insert	MK 180	38.1mm	1 1/2	20mm	80
ST 180/40	center spigot insert	MK 180	40mm		20mm	80

MultiPack

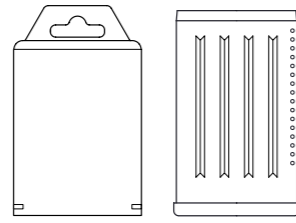

Set packaging solution for drill bits

- with telescopic ratchet feature for variable length adjustment
- available with or without hanger
- efficient packing, easy handling
- durable and reusable
- sturdy, oil, and moisture resistant



PACKAGING

Outer parts and inner parts are packed separately in individual cartons



MATERIAL

- Polyvinylchloride (PVC)
- MP-A 5/7,5 and MP 5/7,5 also in Polypropylene (PP)



COLORS

- PVC clear, PP transparent or in various attractive standard colors or two-colored

USABLE LENGTHS

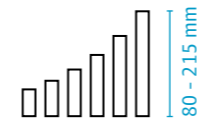

UNIT-Ø



STANDARD COLORS



Product Range

Article	Description	Number of units	Inner diam. unit	Usable length adjustable	PU
MP-A 5/7.5-80	with hanger	5	7.5mm	80 - 120mm	500
MP-A 5/12-100	with hanger	5	10mm	110 - 160mm	500
MP-A 5/12-155	with hanger	5	10mm	165 - 215mm	350
MP-A 7/12-100	with hanger	7	10mm	110 - 160mm	280
MP 5/7,5-80	without hanger	5	7.5mm	80 - 120mm	500
MP 5/12-100	without hanger	5	10mm	110 - 160mm	500
MP 5/12-155	without hanger	5	10mm	165 - 215mm	500
MP 7/12-100	without hanger	7	10mm	110 - 160mm	280

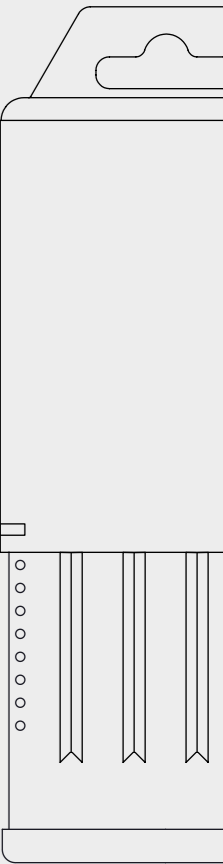

The practical set packaging solution – when there's more than one tool to protect



PlugPack

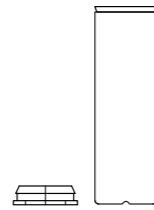

Round plastic packaging tubes in fixed length with secure plug-closure

- square plug prevents rolling
- available in different fixed lengths
- durable and reusable
- sturdy, oil, and moisture resistant



Oh so simple, oh so practical:
universal packaging tube
with the world's simplest
closure (probably)



PACKAGING

Tubes and plugs are packed separately in individual cartons



MATERIAL

- Tubes: Polypropylene (PP)
- Plugs: Polyethylene (PE)
- Recycled plastic



COLORS

- Depending on the material transparent, natural or in various attractive standard colors



ACCESSORIES

- Foam inserts (see page 180)

USABLE LENGTHS

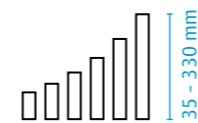

Ø DIAMETER



STANDARD COLORS



Product Range

Article	Inner diam.	Usable length	PU	Article	Inner diam.	Usable length	PU
TP 7 050 A + P 8	8mm	50mm	3200	TP 20 200 A + P 20	22mm	200mm	900
TP 7 075 A + P 8	8mm	75mm	3200	TP 20 220 A + P 20	22mm	220mm	780
TP 9 040 A + P 9	10mm	35mm	2000	TP 22 050 A + P-P 22	24mm	50mm	1000
TP 9 065 A + P 9	10mm	65mm	2000	TP 22 080 A + P-P 22	24mm	80mm	1300
TP 12 040 A + P 12	14mm	40mm	3000	TP 22 120 A + P-P 22	24mm	120mm	800
TP 12 045 A + P 12	14mm	45mm	3000	TP 22 200 A + P-P 22	24mm	200mm	750
TP 12 050 A + P 12	14mm	50mm	2900	TP 24 035 A + P-P 24	26mm	35mm	1400
TP 12 060 A + P 12	14mm	60mm	2200	TP 24 050 A + P-P 24	26mm	50mm	1900
TP 12 070 A + P 12	14mm	70mm	2200	TP 24 080 A + P-P 24	26mm	80mm	1200
TP 12 080 A + P 12	14mm	80mm	3500	TP 24 120 A + P-P 24	26mm	120mm	800
TP 12 120 A + P 12	14mm	120mm	2000	TP 24 200 A + P-P 24	26mm	200mm	650
TP 12 200 A + P 12	14mm	200mm	2100	TP 26 050 A + P-P 26	28mm	50mm	1700
TP 12 240 A + P 12	14mm	240mm	1600	TP 26 080 A + P-P 26	28mm	80mm	850
TP 14 035 A + P 14	16mm	35mm	2200	TP 26 120 A + P-P 26	28mm	120mm	550
TP 14 050 A + P 14	16mm	50mm	2200	TP 26 200 A + P-P 26	28mm	200mm	500
TP 14 060 A + P 14	16mm	60mm	1800	TP 26 330 A + P-P 26	28mm	330mm	320
TP 14 080 A + P 14	16mm	80mm	2800	TP 28 050 A + P 28	30mm	50mm	1400
TP 14 120 A + P 14	16mm	120mm	1600	TP 28 060 A + P 28	30mm	60mm	1000
TP 14 150 A + P 14	16mm	150mm	1200	TP 28 080 A + P 28	30mm	80mm	800
TP 14 200 A + P 14	16mm	200mm	1500	TP 28 120 A + P 28	30mm	120mm	500
TP 16 035 A + P 16	18mm	35mm	2400	TP 28 200 A + P 28	30mm	200mm	450
TP 16 050 A + P 16	18mm	50mm	1700	TP 30 050 A + P-P 30	33mm	50mm	1200
TP 16 080 A + P 16	18mm	80mm	2000	TP 30 080 A + P-P 30	33mm	80mm	650
TP 16 090 A + P 16	18mm	90mm	1800	TP 30 120 A + P-P 30	33mm	120mm	400
TP 16 120 A + P 16	18mm	120mm	1200	TP 30 150 A + P-P 30	33mm	150mm	350
TP 16 200 A + P 16	18mm	200mm	1200	TP 30 190 A + P-P 30	33mm	190mm	430
TP 16 250 A + P 16	18mm	250mm	900	TP 30 200 A + P-P 30	33mm	200mm	400
TP 18 050 A + P 18	20mm	50mm	1500	TP 30 270 A + P-P 30	33mm	270mm	3000
TP 18 080 A + P 18	20mm	80mm	1700	TP 32 050 A + P-P 32	35mm	50mm	1000
TP 18 120 A + P 18	20mm	120mm	1100	TP 32 080 A + P-P 32	35mm	80mm	650
TP 18 200 A + P 18	20mm	200mm	1000	TP 32 120 A + P-P 32	35mm	120mm	400
TP 18 250 A + P 18	20mm	250mm	800	TP 32 200 A + P-P 32	35mm	200mm	350
TP 20 050 A + P 20	22mm	50mm	1200				
TP 20 060 A + P 20	22mm	60mm	2000				
TP 20 070 A + P 20	22mm	70mm	2000				
TP 20 080 A + P 20	22mm	80mm	1500				
TP 20 120 A + P 20	22mm	120mm	1000				



QuadroPack

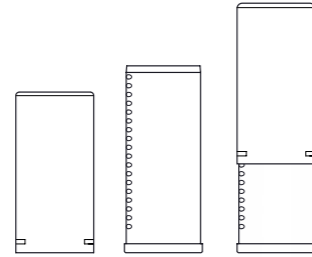

Square telescopic plastic packaging tubes with ratchet length adjustment

- infinitely variable length adjustment via ratchet feature
- speedy efficient packaging
- speedy handling
- excellent for stacking and storage
- durable and reusable
- sturdy, oil, and moisture resistant



Square, practical, easily closable – thanks to ratchet length adjustment. It's no accident that our cuboid multi-talent is among the world's best-selling packaging tubes



PACKAGING
Outer parts and inner parts are packed separately in individual cartons



MATERIAL

- Polyethylene (PE)
- Polypropylene (PP)
- Polyvinylchloride (PVC)
- Recycled plastic
- Bio plastic



COLORS

- Depending on the material transparent, natural or in various attractive standard colors or two-color



ACCESSORIES

- With hangers on request
- Foam inserts (see page 180)

USABLE LENGTHS

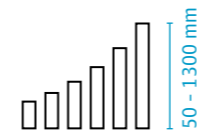

Ø DIAMETER



STANDARD COLORS



Product Range

Article	Inner diam.	Usable length	PU	Article	Inner diam.	Usable length	PU
QP 8 050	8mm	50 - 80mm	2700	QP 26 080	26mm	80 - 120mm	1000
QP 8 080	8mm	80 - 120mm	1700	QP 26 100	26mm	100 - 160mm	800
QP 8 120	8mm	120 - 200mm	2000	QP 26 120	26mm	120 - 200mm	600
QP 8 200	8mm	200 - 350mm	2000	QP 26 200	26mm	200 - 350mm	600
QP 10 050	10mm	50 - 80mm	2100	QP 26 350	26mm	350 - 620mm	340
QP 10 080	10mm	80 - 120mm	2600	QP 32 050	32mm	50 - 70mm	1400
QP 10 120	10mm	120 - 200mm	1400	QP 32 060	32mm	60 - 80mm	1000
QP 10 200	10mm	200 - 350mm	1550	QP 32 080	32mm	80 - 120mm	700
QP 10 250	10mm	250 - 460mm	1200	QP 32 120	32mm	120 - 200mm	450
QP 12 050	12mm	50 - 80mm	3000	QP 32 200	32mm	200 - 350mm	420
QP 12 070	12mm	70 - 110mm	2000	QP 32 350	32mm	350 - 620mm	208
QP 12 080	12mm	80 - 120mm	1800	QP 34 100	34mm	100 - 160mm	450
QP 12 120	12mm	120 - 200mm	1000	QP 35 050	35mm	50 - 70mm	1000
QP 12 200	12mm	200 - 350mm	1000	QP 35 060	35mm	60 - 80mm	750
QP 12 250	12mm	250 - 460mm	850	QP 35 080	35mm	80 - 120mm	600
QP 14 050	14mm	50 - 80mm	2300	QP 35 120	35mm	120 - 200mm	350
QP 14 060	14mm	60 - 85mm	2000	QP 35 200	35mm	200 - 350mm	320
QP 14 065	14mm	65 - 100mm	2000	QP 35 300	35mm	300 - 540mm	210
QP 14 080	14mm	80 - 120mm	1300	QP 35 350	35mm	350 - 620mm	168
QP 14 120	14mm	120 - 200mm	800	QP 45 060	45mm	60 - 80mm	450
QP 14 200	14mm	200 - 350mm	800	QP 45 080	45mm	80 - 120mm	300
QP 14 300	14mm	300 - 535mm	500	QP 45 120	45mm	120 - 200mm	335
QP 16 050	16mm	50 - 80mm	2000	QP 45 200	45mm	200 - 350mm	180
QP 16 080	16mm	80 - 120mm	1100	QP 45 350	45mm	350 - 620mm	99
QP 16 120	16mm	120 - 200mm	1400	QP 45 700	45mm	700 - 1300mm	99
QP 16 200	16mm	200 - 350mm	1400	QP 55 060	55mm	60 - 80mm	300
QP 18 050	18mm	50 - 80mm	1500	QP 55 080	55mm	80 - 120mm	288
QP 18 080	18mm	80 - 120mm	1800	QP 55 120	55mm	120 - 200mm	200
QP 18 120	18mm	120 - 200mm	1100	QP 55 200	55mm	200 - 350mm	120
QP 18 200	18mm	200 - 350mm	1100	QP 55 350	55mm	350 - 620mm	72
QP 20 050	20mm	50 - 80mm	1200	QP 65 080	65mm	80 - 120mm	210
QP 20 080	20mm	80 - 120mm	1600	QP 65 120	65mm	120 - 200mm	155
QP 20 120	20mm	120 - 200mm	900	QP 65 200	65mm	200 - 350mm	92
QP 20 200	20mm	200 - 350mm	900	QP 65 300	65mm	300 - 520mm	65
QP 20 350	20mm	350 - 620mm	500	QP 65 350	65mm	350 - 620mm	56
QP 22 050	22mm	50 - 80mm	1200	QP 78 080	78mm	80 - 120mm	160
QP 22 075	22mm	75 - 105mm	1500	QP 78 120	78mm	120 - 200mm	105
QP 22 080	22mm	80 - 120mm	1300	QP-G78150	78mm	150 - 250mm	80
QP 22 120	22mm	120 - 200mm	850	QP 78 220	78mm	220 - 350mm	56
QP 22 200	22mm	200 - 350mm	840	QP 78 320	78mm	320 - 450mm	42
QP 24 050	24mm	50 - 80mm	850	QP 93 080	93mm	80 - 120mm	90
QP 24 080	24mm	80 - 120mm	1000	QP 93 120	93mm	120 - 200mm	75
QP 24 120	24mm	120 - 200mm	650	QP 93 200	93mm	200 - 350mm	48
QP 24 200	24mm	200 - 350mm	600	QP 93 280	93mm	280 - 450mm	30
QP 26 050	26mm	50 - 60mm	1400				
QP 26 060	26mm	60 - 80mm	1400				

QP-G 78 150 with recessed bottom



RectangularPack

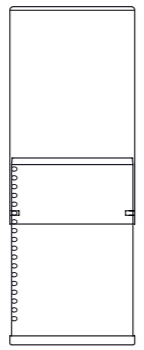

Rectangular telescopic plastic packaging tubes with ratchet length adjustment

- infinitely variable telescopic length adjustment
- speedy efficient packaging
- speedy handling
- excellent for stacking and storage
- durable and reusable
- sturdy, oil, and moisture resistant



 Not everything is round or square – which is why we created this practical packaging tube for everything that's on the flatter side



PACKAGING
Outer parts and inner parts are packed separately in individual cartons



MATERIAL

- Polyethylene (PE)
- Polypropylene (PP)
- Polyvinylchloride (PVC)
- Recycled plastic
- Bio plastic



COLORS

- Depending on the material transparent, natural or in various attractive standard colors or two-color



ACCESSORIES

- With hangers on request

USABLE LENGTHS

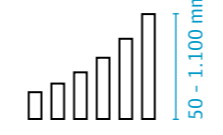

DIMENSION

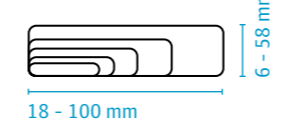

STANDARD COLORS



Product Range

RectangularPack

Article	Inner depth	Inner width	Usable length adjustable	PU	Article	Inner depth	Inner width	Usable length adjustable	PU
RP 6x20/050	6mm	20mm	50-80mm	2000	RP 18x42/200	18mm	42mm	200-360mm	408
RP 6x20/080	6mm	20mm	80-120mm	1000	RP 18x42/240	18mm	42mm	240-420mm	180
RP 6x20/120	6mm	20mm	120-200mm	1000	RP 18x42/335	18mm	42mm	335-580mm	280
RP 6x20/200	6mm	20mm	200-360mm	1000	RP 18x42/620	18mm	42mm	620-1100mm	180
RP 8x36/050	8mm	36mm	50-80mm	1600	RP 19x26/245	19mm	26mm	245-430mm	550
RP 8x36/080	8mm	36mm	80-120mm	1000	RP 19x31/270	19mm	31mm	270-470mm	400
RP 8x36/138	8mm	36mm	138-240mm	450	RP 19x31/295	19mm	31mm	295-520mm	360
RP 8x36/240	8mm	36mm	240-420mm	480	RP-A 23x33/090 ¹	23mm	33mm	90-140mm	700
RP 8x36/420	8mm	36mm	420-780mm	190	RP 25x33/080	25mm	33mm	80-120mm	700
RP 8x36/820	8mm	36mm	820-1100mm	190	RP 26x31/270	26mm	31mm	270-470mm	330
RP 9x45/080	9mm	45mm	80-120mm	550	RP 26x42/060	26mm	42mm	60-80mm	700
RP 9x45/120 I	9mm	45mm	120-160mm	750	RP 26x42/080	26mm	42mm	80-120mm	a.A.
RP 9x45/160 I	9mm	45mm	160-200mm	270	RP 26x42/120	26mm	42mm	120-200mm	400
RP-A 10x22/100 A ¹	10mm	22mm	100-100mm	750	RP 26x42/220	26mm	42mm	220-380mm	320
RP-G 10x22/124 I ²	10mm	22mm	124-175mm	750	RP 26x42/335	26mm	42mm	335-580mm	200
RP-G 10x22/251 I ²	10mm	22mm	251-300mm	250	RP 29x36/080	29mm	36mm	80-120mm	700
RP-G 10x22/350 I ²	10mm	22mm	350-400mm	300	RP 30x65/055	30mm	65mm	55-70mm	650
RP 10x18/080	10mm	18mm	80-120mm	1200	RP 30x65/070	30mm	65mm	70-100mm	520
RP 10x18/120	10mm	18mm	120-200mm	1500	RP 30x65/100	30mm	65mm	100-150mm	350
RP 10x27/070 I	10mm	27mm	70-110mm	850	RP 30x65/130	30mm	65mm	130-200mm	385
RP 10x27/080	10mm	27mm	80-120mm	850	RP 30x65/160	30mm	65mm	160-260mm	300
RP 10x33/120	10mm	33mm	120-200mm	500	RP 30x65/250	30mm	65mm	250-450mm	180
RP 10x33/320	10mm	33mm	320-550mm	240	RP 30x65/300	30mm	65mm	300-550mm	160
RP 12x26/200	12mm	26mm	200-360mm	480	RP 31x56/445	31mm	56mm	445-780mm	100
RP 12x36/360	12mm	36mm	360-620mm	330	RP 33x42/050	33mm	42mm	50-80mm	800
RP 14x36/080	14mm	36mm	80-120mm	650	RP 33x42/335	33mm	42mm	335-580mm	165
RP 16x36/050	16mm	36mm	50-80mm	700	RP 36x62/445	36mm	62mm	445-780mm	80
RP 16x36/080	16mm	36mm	80-120mm	600	RP 40x65/310	40mm	65mm	310-310mm	105
RP 16x36/120	16mm	36mm	120-200mm	350	RP 40x65/540	40mm	65mm	540-540mm	110
RP 16x36/200	16mm	36mm	200-360mm	350	RP 40x75/055	40mm	75mm	55-70mm	450
RP 16x36/360 I	16mm	36mm	360-360mm	200	RP 40x75/070	40mm	75mm	70-100mm	350
RP 16x55/120	16mm	55mm	120-200mm	450	RP 40x75/100	40mm	75mm	100-150mm	320
RP 16x55/200	16mm	55mm	200-360mm	370	RP 40x75/150	40mm	75mm	150-250mm	200
RP-A 17x24/065 ¹	17mm	24mm	65-90mm	1800	RP 40x75/210	40mm	75mm	210-360mm	150
RP 18x42/050	18mm	42mm	50-80mm	1000	RP 40x75/250	40mm	75mm	250-450mm	120
RP 18x42/080	18mm	42mm	80-120mm	850	RP 40x75/400	40mm	75mm	400-700mm	70
RP 18x42/120	18mm	42mm	120-200mm	450	RP 40x100/150	40mm	100mm	150-250mm	132

¹ with hanger, ² for reciprocating saw blades

RectangularPack 58x78

Article	Inner dimension	Length outer part min.- max.	Length inner part min.- max.	Total usable length
RP 58x78	58x78	60-440mm	10-390mm	830mm

RectangularPack MultiBox

Article	Inner dimension	Description	Length outer part min.- max.	Usable length fix
RP 30x65	30x65	cover	50-145mm	60-155mm
RP 30x65/G	30x65	base	40mm	
RP 40x75	40x75	cover	50-95mm	60-105mm
RP 40x75/G	40x75	base	52mm	

RoseSet

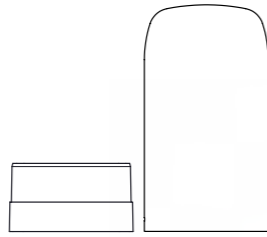

Modern, eye-catching set packaging for presentation, storage and transport. Ideal for sets of all kinds of tools and promotional items

- universal applications
- attractive and handy design
- smart, secure and simple closure
- crystal clear material of cover offers optimum presentation
- can be printed or enhanced by labeling, card inserts, etc.
- 25 or 35 mm recess in base will take punched foam inserts for set layout (not included with RoseSet)



PACKAGING

Outer parts and inner parts are packed separately in individual cartons



MATERIAL

- Base: Polystyrene (PS)
- Cover: Polyvinylchloride (PVC)



COLORS

- Base in blue and red; cover in transparent
- Please inquire for additional colors



ACCESSORIES

- Standard version without euro hanger; please inquire for version with euro hanger

USABLE LENGTHS

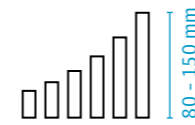

DIMENSION

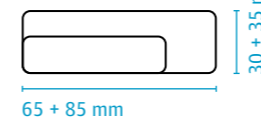

STANDARD COLORS



Product Range

Article	Inner width	Inner height	Usable length	Shank depth	PU
RoseSet 30x65/1/100	30mm	65mm	93mm	25mm	140
RoseSet 30x65/1/150	30mm	65mm	143mm	25mm	210
RoseSet 35x85/1/80	35mm	85mm	70mm	25mm	420
RoseSet 35x85/2/80	35mm	85mm	80mm	35mm	420
RoseSet 35x85/1/110	35mm	85mm	100mm	25mm	420
RoseSet 35x85/2/110	35mm	85mm	110mm	35mm	420
RoseSet 35x85/1/150	35mm	85mm	140mm	25mm	420
RoseSet 35x85/2/150	35mm	85mm	150mm	35mm	420



A good tool set always pleases. All the more so if it's perfectly presented – just like this practical set packaging

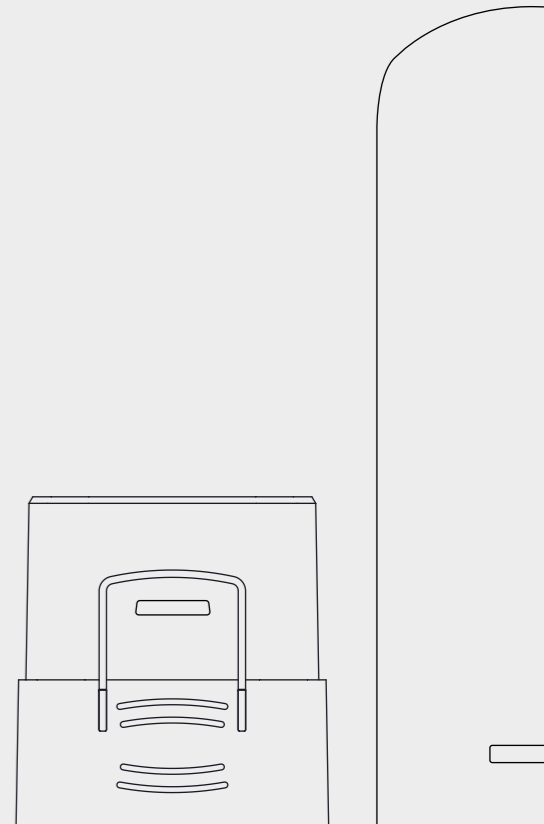

RoundDial-a-Tool

Round plastic containers – ideal set packaging for drill bits, countersinks, jigsaw blades and bits

- compact and stable
- easy twist locking system
- printing on base possible



A well-rounded solution: our set packaging with space for an all-round inscription – timeless, practical, effective



PACKAGING
Outer parts and inner parts are packed separately in individual cartons



MATERIAL
– Polystyrene (PS)



COLORS
– Cover in clear, base in white
– Please inquire for additional colors



ACCESSORIES
– Hanger

LENGTHS

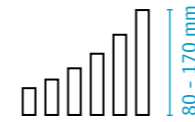

STANDARD COLOR



Product Range

Article	Number of holding devices	Suitable for	Index design	Outer height	PU
RD 01-9460	10	Bits+Magnetic holder	9 bits+1 bit holder 65mm	80mm	150
RD 01-9861	10	Bits+Magnetic holder	9 bits+1 bit holder 75mm	80mm	150
RD 02-9370	10	Bits+Magnetic holder	9 bits+1 bit holder 65mm	90mm	100
RD 02-9858	10	Bits+Magnetic holder	9 bits+1 bit holder 75mm	90mm	100
RD 03-8375	7	HSS drills	1/16"-1/4"x1/32"	125mm	100
RD 03-8376	10	HSS drills	1/16"-1/4"	125mm	100
RD 03-8377	13	HSS drills	1/16"-1/4"x1/64"	125mm	100
RD 03-8427	13	HSS drills	1-7x0.5mm	125mm	100
RD 03-9304	10	HSS/Masonry		125mm	100
RD 03-9371	7	HSS drills	1.5/2/3/4/5/5.5/6mm	125mm	100
RD 03-9373	13	HSS drills	1.5-6.5x0.5mm+3.3mm+4.2mm	125mm	100
RD 03-9377	13	HSS drills	1/16"-1/4"x1/64"	125mm	100
RD 03-9899	11	Saw blades	Saw blades max. lenght 100mm	125mm	100
RD 04-8381	21	HSS drills	1/16"-3/8"x1/64"	145mm	72
RD 04-9380	19	HSS drills	1.0-10.0x0.5mm	145mm	72
RD 04-9382	18	HSS/Masonry/Wood	je 3/4/5/6/8/10mm	145mm	72
RD 04-9385	18	HSS/Masonry/Wood	je 3/4/5/6/7/8mm	145mm	72
RD 04-9955	13	Masonry drills	3-10mm	145mm	72
RD 04-9969	19	HSS/Masonry	1-6x0.5+8+10+4/5/6/8/9/10mm	145mm	72
RD 05-9680	7	SDS drills		170mm	70
RD 05-9683	7	SDS drills	5/6x110mm	170mm	70
RD 05-9689	7	SDS drills	5/6/8x110mm	170mm	70
RD 06-9810	6	Countersinks	90mm	100mm	50
RD 07-8380	19	HSS drills	1-10x0.5mm ANSI	145mm	50
RD 07-8381	21	HSS drills	1/16"-3/8"x1/64"	145mm	50
RD 07-9365	19	HSS/Masonry/Wood	je 3/4/5/6/8/10mm+center punch	145mm	50
RD 07-9380	19	HSS drills	1.0-10.0x0.5mm	145mm	50
RD 07-9382	18	HSS/Masonry/Wood	je 3/4/5/6/8/10mm	145mm	50
RD 07-9385	18	HSS/Masonry/Wood	je 3/4/5/6/7/8mm	145mm	50
RD 07-9388	20	HSS drills	1.0-10.0x0.5mm+1 center punch	145mm	50
RD 07-9675	18	HSS/Masonry	2/3/4/5/6/8+4/5/6/8/10+6Bits+M	145mm	50
RD 07-9693	11	HSS/Masonry/Wood	3/4/5/6mm+5/6/8mm+4/5/6/8mm	145mm	50
RD 07-9719	12	Masonry drills	3/4/4/5/5/6/6/7/8/8/9/10mm	145mm	50
RD 07-9733	15	Masonry drills	3-10x0.5mm	145mm	50
RD 07-9955	13	Masonry drills	3-10mm	145mm	50
RD 07-9969	19	HSS/Masonry	1-6x0.5+8+10+4/5/6/8/9/10mm	145mm	50
RD 08-9883	18	Bits+Magnetic holder	17 Bits+Magnetic holder	90mm	90



ChuckPack

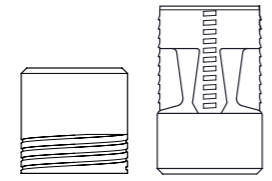

Protective packaging tubes for SK 40/SK 45/SK 50 steep taper tool holders

- tool is safely locked in packaging
- speedy efficient packaging
- easy removing
- extremely strong
- durable and reusable
- length adjustable cover
- round and square base available



 Protect your steep taper tool holder – in this sturdy and secure special packaging



PACKAGING
Outer parts and inner parts are packed separately in individual cartons



MATERIAL
- Polyethylene (PE)
- Recycled plastic
- Bio plastic



COLORS
- Depending on the material natural or in various attractive standard colors



ACCESSORIES
- Foam inserts (see page 180)

TOOL LENGTHS

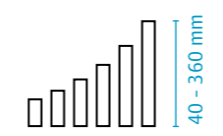

SUITABLE FOR

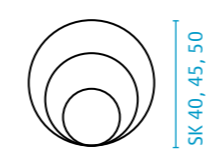

STANDARD COLORS



Product Range

ChuckPack SK 40

Article	Description	Suitable for	Length	For tool length (w/o cone)	PU
SK 40 095 A	cover no. 1/95	tool holder SK 40	95mm	40 - 105mm	180
SK 40 160 A	cover no. 2/160	tool holder SK 40	160mm	105 - 160mm	120
SK 40 225 A	cover no. 3/225	tool holder SK 40	225mm	160 - 225mm	80
SK 40 290 A	cover no. 4/290	tool holder SK 40	290mm	225 - 290mm	64
SK 40 355 A	cover no. 5/355	tool holder SK 40	355mm	290 - 355mm	50
SK 40-4K I	base square	tool holder SK 40			140
SK 40 I	base round	tool holder SK 40			140

ChuckPack SK 45

Article	Description	Suitable for	Length	For tool length (w/o cone)	PU
SK 45 103 A	cover no. 1/103	tool holder SK 45	103mm	45 - 105mm	100
SK 45 168 A	cover no. 2/168	tool holder SK 45	168mm	105 - 165mm	60
SK 45 233 A	cover no. 3/233	tool holder SK 45	233mm	165 - 230mm	44
SK 45 298 A	cover no. 4/298	tool holder SK 45	298mm	230 - 295mm	36
SK 45 363 A	cover no. 5/363	tool holder SK 45	363mm	295 - 360mm	25
SK 45-4K I	base square	tool holder SK 45			65

ChuckPack SK 50

Article	Description	Suitable for	Length	For tool length (w/o cone)	PU
SK 50 113 A	cover no. 1/113	tool holder SK 50	113mm	45 - 110mm	65
SK 50 178 A	cover no. 2/178	tool holder SK 50	178mm	110 - 175mm	39
SK 50 243 A	cover no. 3/243	tool holder SK 50	243mm	175 - 240mm	26
SK 50 308 A	cover no. 4/308	tool holder SK 50	308mm	240 - 305mm	20
SK 50 358 A	cover no. 5/358	tool holder SK 50	358mm	305 - 355mm	18
SK 50-4K I	base square	tool holder SK 50			39
SK 50 I	base round	tool holder SK 50			39

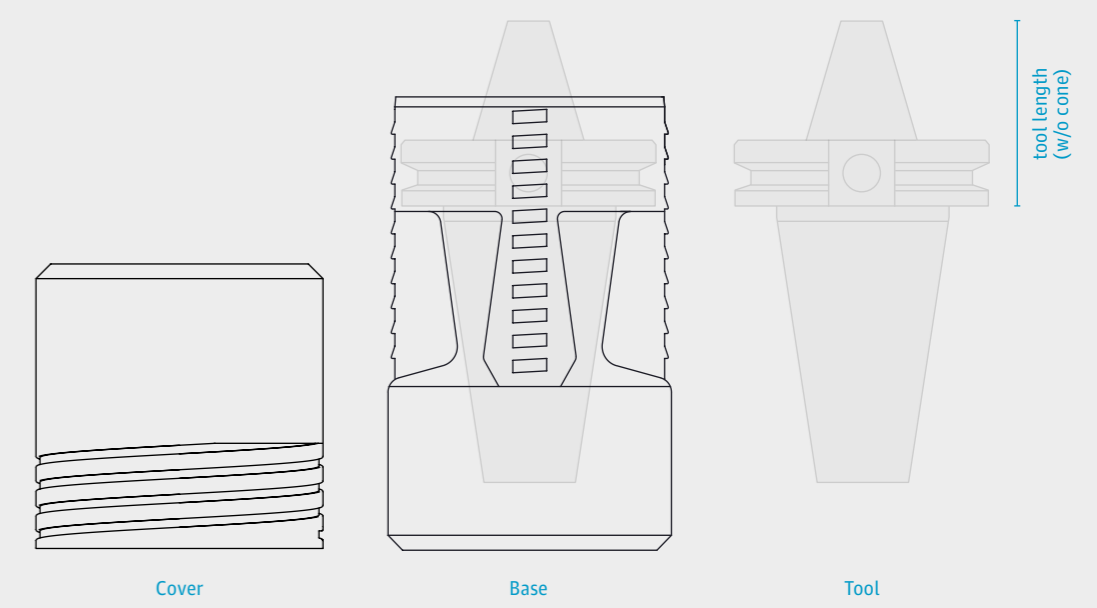



SK-Pack CenterLock

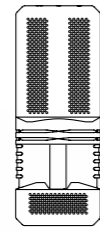

Protective packaging tubes with Center-Lock closure technology – ideal for steep taper tool holders SK 40 and SK 50

- simple handling due to "Center-Lock closure technology"
- efficient packaging - fast & easy loading and unpacking
- highly secure closure, but with minimal force in opening and closing the pack
- perfect protection by optimized product design and sturdy, impact resistant polyethylene
- variable length adjustment
- dimpled surface structure assists in providing a "non-slip" feature for stacking and storage
- durable and reusable
- taper shank is safely locked in the packaging
- embossing of customer brandings possible
- sturdy, oil, and moisture resistant



 Centers and protects your steep taper tool holder – a safe bet



PACKAGING
Outer parts and inner parts are packed separately in individual cartons



MATERIAL
– Polyethylene (PE)
– Recycled plastic
– Bio plastic



COLORS
– Depending on the material natural or in various attractive standard colors

TOOL LENGTHS

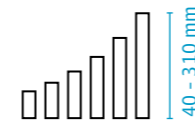

SUITABLE FOR

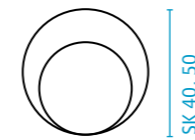

STANDARD COLORS



Product Range

SK-Pack CenterLock SK 40

Article	Description	Suitable for	Length	For tool length (w/o cone)	PU
SKCL 40 110/2 A	cover w/dimpled surface	tool holder SK 40	110mm	40 - 100mm	150
SKCL 40 180/2 A	cover w/dimpled surface	tool holder SK 40	180mm	110 - 170mm	90
SKCL 40 250/2 A	cover w/dimpled surface	tool holder SK 40	250mm	180 - 240mm	73
SKCL 40 320/2 A	cover w/dimpled surface	tool holder SK 40	320mm	250 - 310mm	50
SKCL 40/2 I	base w/ dimpled surface	tool holder SK 40			105

SK-Pack CenterLock SK 50

Article	Description	Suitable for	Length	For tool length (w/o cone)	PU
SKCL 50 110/2 A	cover w/dimpled surface	tool holder SK 50	110mm	40 - 100mm	60
SKCL 50 180/2 A	cover w/dimpled surface	tool holder SK 50	180mm	110 - 170mm	40
SKCL 50 250/2 A	cover w/dimpled surface	tool holder SK 50	250mm	180 - 240mm	28
SKCL 50 320/2 A	cover w/dimpled surface	tool holder SK 50	320mm	250 - 310mm	20
SKCL 50/2 I	base w/ dimpled surface	tool holder SK 50			40

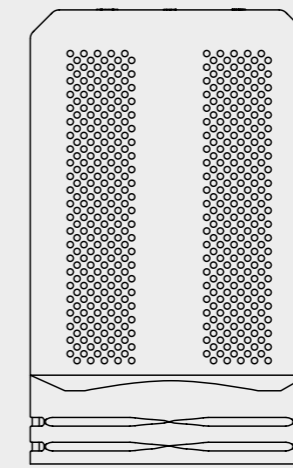

Cover

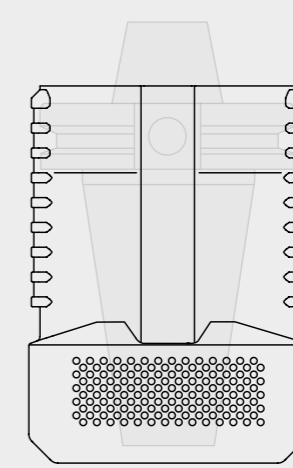

Base

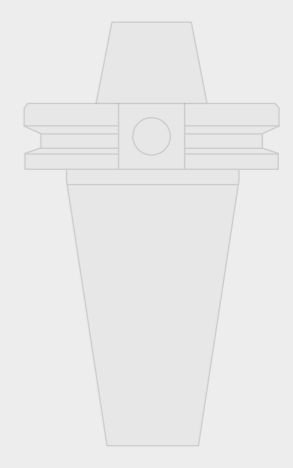

Tool

tool length (w/o cone)

SlimPack

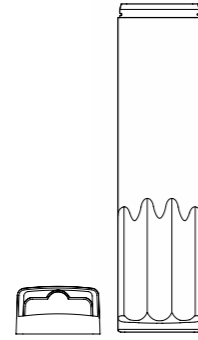

Transparent, thin-walled plastic packaging tube – ideal for SDS drills

- highly transparent plastic maximises product visibility
- thin walled plastic for ultra light weight
- unbreakable high-quality polystyrene offers stability and perfect protection
- plug with integrated euroslot
- durable and reusable
- easy to equip with cardboard inserts, labels etc.



PACKAGING

Outer parts and inner parts are packed separately in individual cartons



MATERIAL

- Tube: Polystyrene (PS)
- Hanger: Polypropylene (PP)



COLORS

- Tube in transparent, hanger in various attractive standard colors

LENGTH



DIMENSION



STANDARD COLORS



Product Range

Article	Description	Inner width	Inner depth	Inner length	PU
SLH 10x43/1	hanger	43mm	10mm		2500
SLT 10x43x170/4	tube, 3 compartments Ø10 mm	43mm	10mm	170mm	450

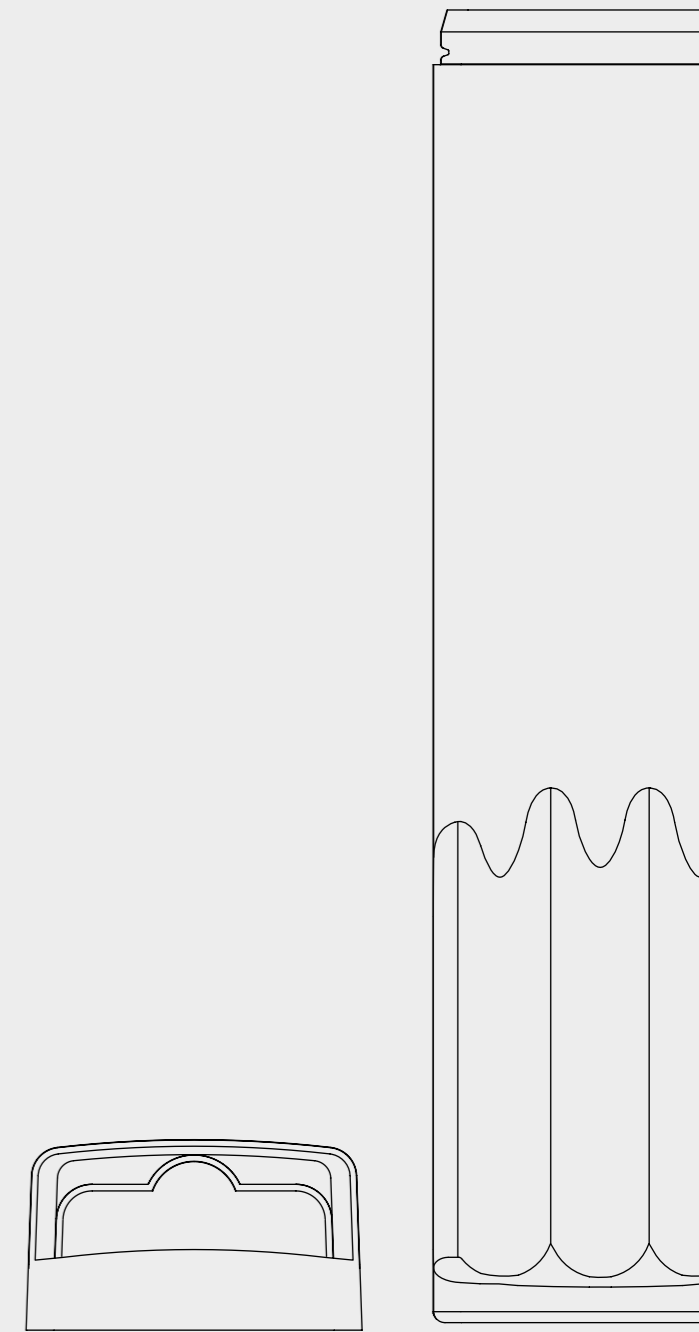

Your tools need protection and visibility – not unnecessary bells and whistles. This proven protective packaging understands what product presentation really means



SZ-PlugPack

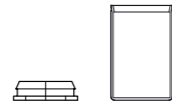

Plastic packaging tubes with secure plug-closure – ideal storage solution for ER collets

- fixed length tube designed to accommodate ER collets
- sturdy packaging tube with secure plug-closure
- square plug prevents rolling
- extremely strong
- durable and reusable
- oil resistant



So simple and useful that there's not much to say. Put the plug on it – and your product is perfectly protected



PACKAGING
Tubes and Plugs are packed separately in individual cartons



MATERIAL

- Tube: Polypropylene (PP)
- Plug: Polyethylene (PE)
- Recycled plastic



COLORS

- Depending on the material transparent, natural or in various attractive standard colors

USABLE LENGTHS

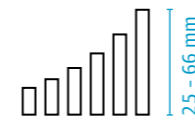

Ø DIAMETER

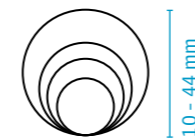

STANDARD COLORS



Product Range

Tubes

Article	Part type	Inner diam.	Inner length	Suitable for ER collets	PU
SZ 9 025	outer part	10mm	25mm	ER 8 Ø8.5 x L=13.5mm	5000
SZ 12 025	outer part	14mm	25mm	ER 11 Ø11.5 x L=18mm	2500
SZ 16 030	outer part	18mm	30mm	ER 16 Ø17 x L=27.5mm	2500
SZ 20 032	outer part	22mm	32mm	ER 20 Ø21 x L=31.5mm	2000
SZ 24 038	outer part	26mm	38mm	ER 25 Ø26 x L=34mm	1200
SZ 24 045	outer part	26mm	46mm	ER 25	1000
SZ 32 040	outer part	35mm	42mm	ER 32 Ø33 x L=40mm	1400
SZ 32 055	outer part	35mm	58mm	ER 32	1000
SZ 42 045	outer part	44mm	48mm	ER 40 Ø41 x L=46mm	750
SZ 42 065	outer part	44mm	66mm	ER 40	500

Plugs

Article	Part type	Diameter	Suitable for	PU
PZ 09	plug	9mm	SZ 9 025	5000
PZ 12	plug	12mm	SZ 12 025	2500
PZ 16	plug	16mm	SZ 16 030	2500
PZ 20	plug	20mm	SZ 20 032	2000
PZ 24	plug	24mm	SZ 24 038 + SZ 24 045	2000
PZ 32	plug	32mm	SZ 32 040 + SZ 32 055	1500
PZ 42	plug	42mm	SZ 42 045 + SZ 42 065	1000

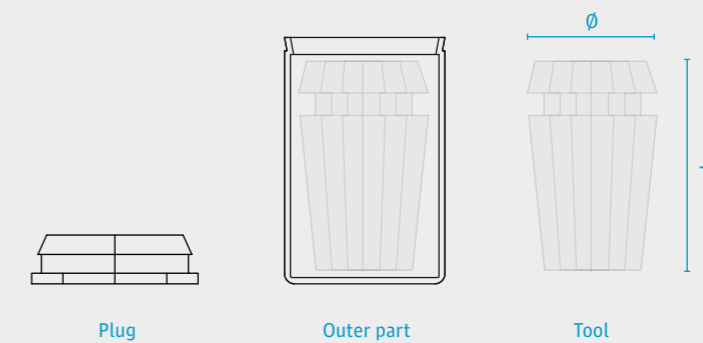



TelePack

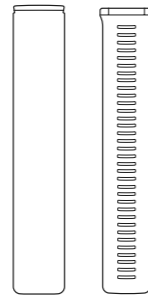

Round telescopic plastic packaging tubes with ratchet length adjustment and roll-away protection

- telescopic length extension, ratchet mechanism locks package into extended position
- square end prevents rolling
- durable and reusable
- sturdy, oil, and moisture resistant



PACKAGING
Outer parts and inner parts are packed separately in individual cartons



MATERIAL

- Polypropylene (PP)
- Polyethylene (PE)
- Recycled plastic
- Bio plastic



COLORS

- Depending on the material transparent, natural or in various attractive standard colors



ACCESSORIES

- With hanger on request

USABLE LENGTHS

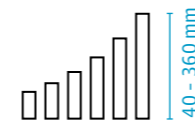

Ø DIAMETER



STANDARD COLORS



Product Range

Article	Inner diam.	Usable length (adjustable)	PU
TP 7 050	7mm	50 - 90mm	3200
TP 7 075	7mm	75 - 115mm	3200
TP 9 040	9mm	40 - 65mm	2000
TP 9 065	9mm	65 - 110mm	2000
TP 12 050	12mm	50 - 80mm	2900
TP 12 080	12mm	80 - 120mm	3500
TP 12 120	12mm	120 - 200mm	2000
TP 12 200	12mm	200 - 360mm	2100
TP 14 050	14mm	50 - 80mm	2200
TP 14 080	14mm	80 - 120mm	2800
TP 14 120	14mm	120 - 200mm	1600
TP 14 200	14mm	200 - 360mm	1500
TP 16 050	16mm	50 - 80mm	1700
TP 16 080	16mm	80 - 120mm	2000
TP 16 120	16mm	120 - 200mm	1200
TP 16 200	16mm	200 - 360mm	1200
TP 18 050	18mm	50 - 80mm	1500
TP 18 080	18mm	80 - 120mm	1700
TP 18 120	18mm	120 - 200mm	1100
TP 18 200	18mm	200 - 360mm	1000
TP 20 050	20mm	50 - 80mm	1200
TP 20 080	20mm	80 - 120mm	1500
TP 20 120	20mm	120 - 200mm	1000
TP 20 200	20mm	200 - 360mm	900
TP 22 050	22mm	50 - 80mm	1000
TP 22 080	22mm	80 - 120mm	1300
TP 22 120	22mm	120 - 200mm	800
TP 22 200	22mm	200 - 360mm	750
TP 24 050	24mm	50 - 80mm	1900
TP 24 080	24mm	80 - 120mm	1200
TP 24 120	24mm	120 - 200mm	800
TP 24 200	24mm	200 - 360mm	650
TP 26 050	26mm	50 - 80mm	1700
TP 26 080	26mm	80 - 120mm	850
TP 26 120	26mm	120 - 200mm	550
TP 26 200	26mm	200 - 360mm	500
TP 28 050	28mm	50 - 80mm	1400
TP 28 080	28mm	80 - 120mm	800
TP 28 120	28mm	120 - 200mm	500
TP 28 200	28mm	200 - 360mm	450
TP 30 050	30mm	50 - 80mm	1200
TP 30 080	30mm	80 - 120mm	650
TP 30 120	30mm	120 - 200mm	400
TP 30 200	30mm	200 - 360mm	400
TP 32 050	32mm	50 - 80mm	1000
TP 32 080	32mm	80 - 120mm	650
TP 32 120	32mm	120 - 200mm	400
TP 32 200	32mm	200 - 360mm	350



The telescopic length adjustment was the inspiration for the name of this practical and versatile packaging tube – a sought-after classic in our product range

TopPack

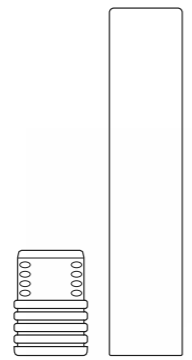

High-quality packaging tubes with short shankholding base-plug or telescopic inner part. Ideal for solid carbide cutters

- attractive design
- high protection for tool cutting edges
- groove in bottom part makes opening easy
- durable and reusable
- telescopic inner parts with ratchet length adjustment
- center adaptor to support and secure tool
- sturdy, oil, and moisture resistant



Simply top – and always the right packaging for optimum protection of your shank tools



PACKAGING
Outer parts and inner parts are packed separately in individual cartons



MATERIAL
- Polyethylene (PE)
- Polypropylene (PP)



COLORS
- Outer part in transparent
- Base plug and inner part in various attractive standard colors



ACCESSORIES
- TopPack Adaptor Cap
- TopPack Center Adaptor
- ProtectiveCap (see page 176)
- Protective Sleeves (see page 184)
- TopPack FiveFrame (see page 188)

USABLE LENGTHS

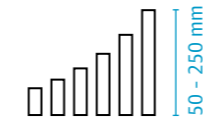

SHANK DIAM.



STANDARD COLORS



Product Range

Base plug / inner part

Article	Part type	Diameter	Shank diam.	Shank diam. (in.)	Inner length	PU
TPK 8x18-3/1 I	base plug	8mm	3mm		18mm	1000
TPK 8x18-1/8"/1 I	base plug	8mm	3.175mm	1/8"	18mm	1000
TPK 8x18-4/1 I	base plug	8mm	4mm		18mm	1000
TPK 8x18-3/16"/1 I	base plug	8mm	4.762mm	3/16"	18mm	1000
TPK 8x18-5/1 I	base plug	8mm	5mm		18mm	1000
TPK 8x18-6/1 I	base plug	8mm	6mm		18mm	1000
TPK 8x18-1/4"/1 I	base plug	8mm	6.35mm	1/4"	18mm	1000
TPK 8x18-8/1 I	base plug	8mm	8mm		18mm	1000
TPK 8x58/1 I	telescop inner part	8mm			58mm	1000
TPK 13x25-3/1 I	base plug	13mm	3mm		25mm	1000
TPK 13x25-4/1 I	base plug	13mm	4mm		25mm	1000
TPK 13x25-5/1 I	base plug	13mm	5mm		25mm	1000
TPK 13x25-6/1 I	base plug	13mm	6mm		25mm	1000
TPK 13x25-1/4"/1 I	base plug	13mm	6.35mm	1/4"	25mm	1000
TPK 13x25-7/1 I	base plug	13mm	7mm		25mm	1000
TPK 13x25-8/1 I	base plug	13mm	8mm		25mm	1000
TPK 13x25-9/1 I	base plug	13mm	9mm		25mm	1000
TPK 13x25-3/8"/1 I	base plug	13mm	9.525mm	3/8"	25mm	1000
TPK 13x25-10/1 I	base plug	13mm	10mm		25mm	1000
TPK 13x25-7/16"/1 I	base plug	13mm	11.11mm	7/16"	25mm	1000
TPK 13x25-12/1 I	base plug	13mm	12mm		25mm	1000
TPK 13x25-1/2"/1 I	base plug	13mm	12.7mm	1/2"	25mm	1000
TPK 13x60/1 I	telescop inner part	13mm			60mm	500
TPK 13x79/1 I	telescop inner part	13mm			79mm	1000
TPK 18x34-14/1 I	base plug	18mm	14mm		34mm	500
TPK 18x34-9/16"/1 I	base plug	18mm	14.287mm	9/16"	34mm	500
TPK 18x34-5/8"/1 I	base plug	18mm	15.875mm	5/8"	34mm	500
TPK 18x34-16/1 I	base plug	18mm	16mm		34mm	500
TPK 18x90/1 I	telescop inner part	18mm			90mm	500
TPK 20x40-18/1 I	base plug	21mm	18mm		40mm	250
TPK 20x40-3/4"/1 I	base plug	21mm	19.05mm	3/4"	40mm	250
TPK 20x40-20/1 I	base plug	21mm	20mm		40mm	250
TPK 20x91/1 I	telescop part	21mm			91mm	500
TPK 26x136/1 I	telescop inner part	26mm			136mm	300
TPK 32x155/1 I	telescop inner part	32mm			155mm	150

Product Range

Outer part

Article	Part type	Diam.	Inner length	Suitable inner part	Usable length	PU
TPK 8x42 A	outer part	8mm	42mm	TPK 8 base plug	50mm	1000
				TPK 8x58/1 I telescop inner part	58-90mm	1000
TPK 8x52 A	outer part	8mm	52mm	TPK 8 base plug	60mm	1000
				TPK 8x58/1 I telescop inner part	60-100mm	1000
TPK 8x70 A	outer part	8mm	70mm	TPK 8 base plug	77mm	1000
				TPK 8x58/1 I telescop inner part	77-118mm	1000
TPK 8x85/2 A*	outer part	8mm	85mm	TPK 8 base plug	92mm	2300
				TPK 8x97 A	105mm	1000
TPK 8x97/2 A*	outer part	8mm	97mm	TPK 8 base plug	105-135mm	1000
				TPK 8x97/1 I telescop inner part	105-135mm	1000
TPK 13x56 A	outer part	13mm	56mm	TPK 13 base plug	66mm	500
				TPK 13x60/1 I telescop inner part	66-100mm	500
				TPK 13x79/1 I telescop inner part	79-119mm	500
				TPK 13x74 A	84mm	500
TPK 13x74 A	outer part	13mm	74mm	TPK 13 base plug	84mm	500
				TPK 13x60/1 I telescop inner part	84-119mm	500
				TPK 13x79/1 I telescop inner part	84-138mm	500
				TPK 13x88 A	98mm	500
TPK 13x88 A	outer part	13mm	88mm	TPK 13 base plug	98mm	500
				TPK 13x60/1 I telescop inner part	98-131.5mm	500
				TPK 13x79/1 I telescop inner part	98-150.5mm	500
				TPK 13x97 A	108mm	500
TPK 13x97 A	outer part	13mm	97mm	TPK 13 base plug	108mm	500
				TPK 13x60/1 I telescop inner part	108-142mm	500
				TPK 13x79/1 I telescop inner part	108-161mm	500
				TPK 13x110 A	120mm	500
TPK 13x110 A	outer part	13mm	110mm	TPK 13 base plug	120mm	500
				TPK 13x60/1 I telescop inner part	120-155mm	500
				TPK 13x79/1 I telescop inner part	120-174mm	500
				TPK 18x83 A	98mm	500
TPK 18x83 A	outer part	18mm	83mm	TPK 18 base plug	98mm	500
				TPK 18x90/1 I telescop inner part	98-154mm	500
TPK 18x113 A	outer part	18mm	113mm	TPK 18 base plug	129mm	500
				TPK 18x90/1 I telescop inner part	129-188.5mm	500
TPK 18x130 A	outer part	18mm	130mm	TPK 18 base plug	144mm	250
				TPK 18x90/1 I telescop inner part	144-200mm	250
TPK 18x145/2 A*	outer part	18mm	145mm	TPK 18 base plug	158mm	500
				TPK 20x89 A	108mm	250
TPK 20x89 A	outer part	20mm	89mm	TPK 20 base plug	108mm	250
				TPK 20x91/1 I telescop inner part	108-154mm	250
TPK 20x130 A	outer part	20mm	130mm	TPK 20 base plug	149mm	250
				TPK 20x91/1 I telescop inner part	149-195mm	250
TPK 26x124 A	outer part	26mm	124mm	TPK 26x136/1 I telescop inner part	145-220mm	300
				TPK 32x145 A	170-250	150
TPK 32x145 A	outer part	32mm	145mm	TPK 32x155/1 I telescop inner part	170-250	150

*Outer part made of PVC

Accessories for telescop inner part

Article	Part type	Suitable for	Shank diam.	PU	Article	Part type	Suitable for	Shank diam.	PU
TKA 8-3/4	adaptor cap	TPK Ø 8	3-5mm	1000	TKA 8-3/3	center adaptor	TPK Ø 8	3-5mm	1000
TKA 13-3/4	adaptor cap	TPK Ø 13	3-6mm	1000	TKA 13-3/3	center adaptor	TPK Ø 13	3-6mm	1000
TKA 13-6/4	adaptor cap	TPK Ø 13	6-8mm	1000	TKA 13-6/3	center adaptor	TPK Ø 13	6-8mm	1000
TKA 18-8/4	adaptor cap	TPK Ø 18	8-14mm	1000	TKA 18-8/3	center adaptor	TPK Ø 18	8-14mm	1000
TKA 20-10/4	adaptor cap	TPK Ø 20	10-16mm	500	TKA 20-10/3	center adaptor	TPK Ø 20	10-16mm	500
TKA 26-16/4	adaptor cap	TPK Ø 26	16-22mm	300	TKA 26-16/3	center adaptor	TPK Ø 26	16-22mm	300
TKA 32-20/4	adaptor cap	TPK Ø 32	20-28mm	300	TKA 32-20/3	center adaptor	TPK Ø 32	20-28mm	300



PACKAGING

Outer parts and inner parts are packed separately in individual cartons



MATERIAL

- Polyethylene (PE)
- Polypropylene (PP)



COLORS

- Outer part in transparent
- Base plug and inner part in various attractive standard colors



ACCESSORIES

- TopPack Adaptor Cap
- TopPack Center Adaptor
- ProtectiveCap (see page 176)
- Protective Sleeves (see page 184)
- TopPack FiveFrame (see page 188)

USABLE LENGTHS

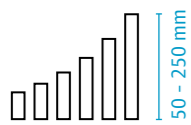

SHANK DIAM.

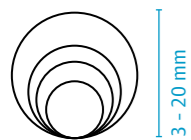

STANDARD COLORS



Good to know

Top tool protection with TopPack. It's so easy.

Effective and simple: perfect protection for your shank tools – with TopPack from rose plastic and our well-thought-out accessories.

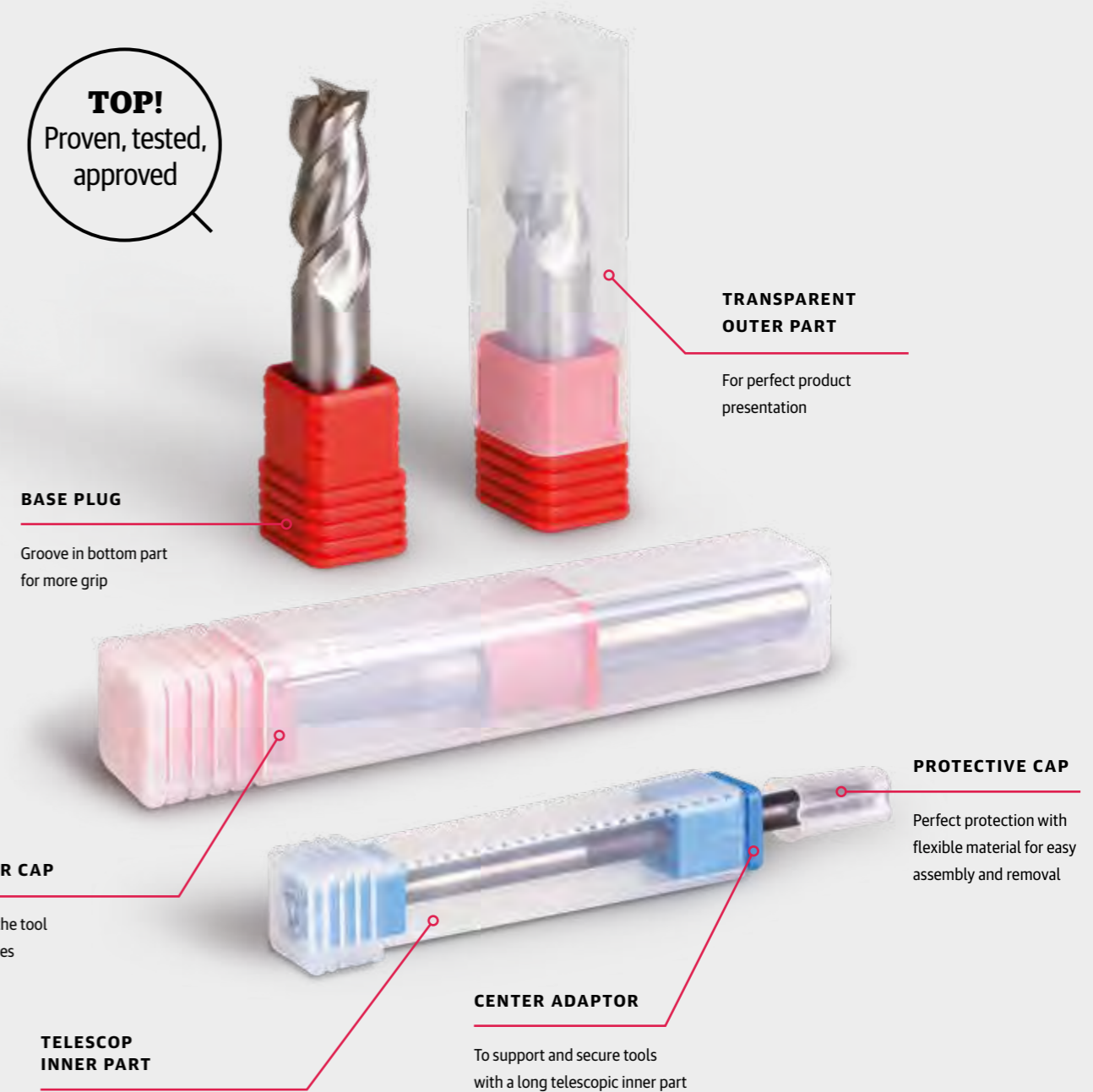

TopPackConical

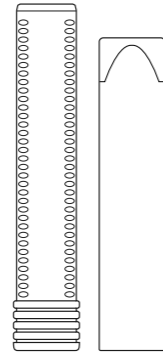

Plastic packaging tubes for solid carbide cutters and solid carbide drills

- universal application for tools with different dimensions due to ratchet length adjustment
- in TopPack inner and outer tubes, shank tools, milling cutters, and drills are centrally positioned in the pack – regardless of tool diameter
- delicate cutting edges are protected by the internal conical ribs
- grooves in bases provide good grip for easy opening
- durable and reusable
- sturdy, oil, and moisture resistant



PACKAGING
Outer parts and inner parts are packed separately in individual cartons



MATERIAL
- Polypropylene (PP)



COLORS
- PP transparent or in various attractive standard colors

USABLE LENGTHS

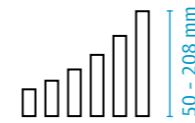

SHANK DIAM.

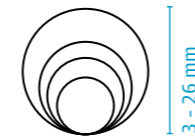

STANDARD COLORS



Product Range

Article	Part type	Shank diam.	Inner length	Suitable Inner part	Usable length*	PU
TPKZR 8x42 A	outer part	3-8mm	42mm	TPKZR 8x38 /1 I	50-67mm	1000
				TPKZR 8x58 /1 I	60-81mm	
TPKZR 8x52 A	outer part	3-8mm	52mm	TPKZR 8x38 /1 I	58-77mm	1000
				TPKZR 8x58 /1 I	60-91mm	
TPKZR 8x70 A	outer part	3-8mm	70mm	TPKZR 8x38 /1 I	76-95mm	1000
				TPKZR 8x58 /1 I	72-109mm	
TPKZR 8x38/1 I	inner part	3-8mm	38mm			1000
TPKZR 8x58/1 I	inner part	3-8mm	58mm			1000
TPKZR 13x56 A	outer part	6-13mm	56mm	TPKZR 13x60 /1 I	62-87mm	500
				TPKZR 13x79 /1 I	82-117mm	
TPKZR 13x74 A	outer part	6-13mm	74mm	TPKZR 13x60 /1 I	76-105mm	1000
				TPKZR 13x79 /1 I	82-125mm	
TPKZR 13x97 A	outer part	6-13mm	97mm	TPKZR 13x60 /1 I	100-130mm	500
				TPKZR 13x79 /1 I	100-150mm	
TPKZR 13x60/1 I	inner part	6-13mm	60mm			500
TPKZR 13x79/1 I	inner part	6-13mm	79mm			1000
TPKZR 18x45 A	outer part	14-18mm	45mm	TPKZR 18x47 /1 I	51-72mm	500
				TPKZR 18x61 /1 I	69-86mm	
TPKZR 18x63 A	outer part	14-18mm	63mm	TPKZR 18x61 /1 I	69-100mm	500
TPKZR 18x83 A	outer part	14-18mm	83mm	TPKZR 18x90 /1 I	100-148mm	500
TPKZR 18x47/1 I	inner part	14-18mm	47mm			500
TPKZR 18x61/1 I	inner part	14-18mm	61mm			500
TPKZR 18x90/1 I	inner part	14-18mm	90mm			500
TPKZR 20x62 A	outer part	14-20mm	62mm	TPKZR 20x70 /1 I	75-102mm	250
TPKZR 20x89 A	outer part	14-20mm	89mm	TPKZR 20x91 /1 I	103-155mm	250
TPKZR 20x70/1 I	inner part	14-20mm	70mm			250
TPKZR 20x91/1 I	inner part	14-20mm	91mm			250
TPKZR 26x82 A	outer part	20-26mm	82mm	TPKZR 26x90 /1 I	100-138mm	300
				TPKZR 26x136 /1 I	138-184mm	
TPKZR 26x124 A	outer part	20-26mm	124mm	TPKZR 26x90 /1 I	138-180mm	300
				TPKZR 26x136 /1 I	138-208mm	
TPKZR 26x90/1 I	inner part	20-26mm	90mm			300
TPKZR 26x136/1 I	inner part	20-26mm	136mm			300

*The usable lengths are mean values and may vary depending on the tool diameter.

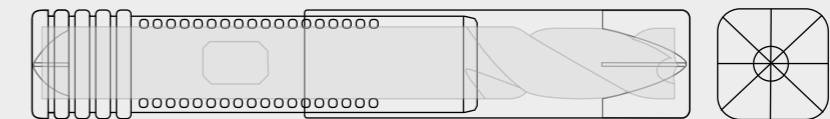

No need for height control – the perfect packaging tube for tools with different dimensions thanks to flexible length adjustment

TopPack FoldBack

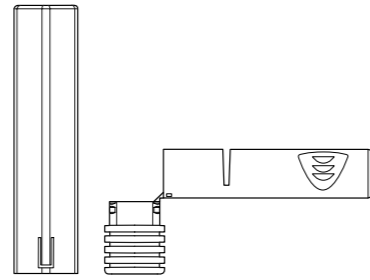

Plastic packaging tubes with ,PLUS' clamping device for optimum protection of micro tools

- encapsulated fold back design and outer cover provides optimum protection for delicate tools
- easy loading and unloading due to the fold back design
- tight fit of tool provided by shank clamping device in the back part; also available: "PLUS" clamping device for highly polished and smooth tool shanks
- durable hinge design creates reusability of the package
- coding by different color versions of the "PLUS" clamping device possible
- incorporated grooves provide grip for easy opening
- outer parts are transparent for product identification
- sturdy, oil, and moisture resistant



 Perfectly wrapped – safely packed. Excellent protection for sensitive tool tips



PACKAGING

Outer parts and inner parts are packed separately in individual cartons



MATERIAL

- Inner part: Polypropylene (PP)
- Inner part with "PLUS" clamping device: Polypropylen (PP) with TPE
- Outer part: Polypropylene (PP)



COLORS

- Outer part in transparent
- Inner part in transparent or in various attractive standard colors
- PLUS clamping device in red, blue and natural; further colors and color combinations on request



ACCESSORIES

- TopPack FiveFrame (see page 188)

USABLE LENGTHS

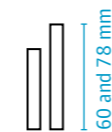

SHANK DIAM.

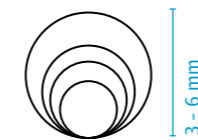

STANDARD COLORS



Product Range

Inner part

Article	Part type	Diameter	Shank diam.	PU
TPKFO 8-3 I	inner part	8mm	3mm	1000
TPKFO 8-3.175 I	inner part	8mm	3.175mm	1000
TPKFO 8-4 I	inner part	8mm	4mm	1000
TPKFO 8-5 I	inner part	8mm	5mm	1000
TPKFO 8-6 I	inner part	8mm	6mm	1000
TPKFO 8-3 PLUS/2 I	inner part w/ PLUS clamping	8mm	3mm	1000
TPKFO 8-3.175 PLUS I	inner part w/ PLUS clamping	8mm	3.175mm	1000
TPKFO 8-4 PLUS/2 I	inner part w/ PLUS clamping	8mm	4mm	1000
TPKFO 8-5 PLUS I	inner part w/ PLUS clamping	8mm	5mm	1000
TPKFO 8-6 PLUS/2 I	inner part w/ PLUS clamping	8mm	6mm	1000

Outer part

Article	Part type	Diameter	Inner length	Usable length	PU
TPK 8x52 A	outer part	8mm	52mm	60mm	1000
TPK 8x70 A	outer part	8mm	70mm	78mm	1000

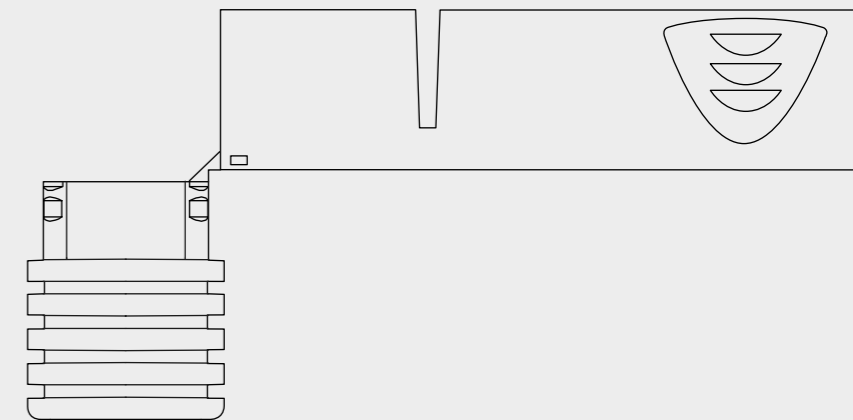

TopPackWing

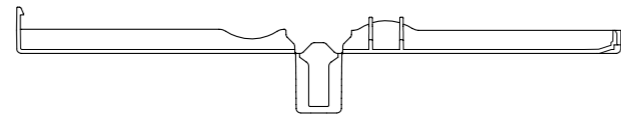

One-piece plastic packaging tubes for solid carbide shank tools

- total protection for delicate tool tips due to complete coverage
- simple handling due to the hinged 'wings'
- easy loading/unloading due to the hinge design
- additional support through integral shankholding fixings
- durable and reusable
- sturdy, oil, and moisture resistant



PACKAGING
Carton



MATERIAL
- Polypropylene (PP)



COLORS
- PP transparent or in various attractive standard colors

USABLE LENGTHS

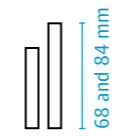

Ø DIAMETER

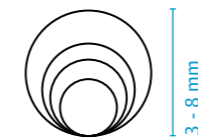

STANDARD COLORS



Product Range

Article	Diameter	Shank diam.	Usable length fixed	PU
TPKW 8x68-3/1	8mm	3mm	68mm	1000
TPKW 8x68-3.175/1	8mm	3.175mm	68mm	1000
TPKW 8x68-4/1	8mm	4mm	68mm	1000
TPKW 8x68-5/1	8mm	5mm	68mm	1000
TPKW 8x68-6/1	8mm	6mm	68mm	1000
TPKW 8x68-8/1	8mm	8mm	68mm	1000
TPKW 8x84-3/1	8mm	3mm	84mm	1000
TPKW 8x84-3.175/1	8mm	3.175mm	84mm	1000
TPKW 8x84-4/1	8mm	4mm	84mm	1000
TPKW 8x84-5/1	8mm	5mm	84mm	1000
TPKW 8x84-6/1	8mm	6mm	84mm	1000
TPKW 8x84-8/1	8mm	8mm	84mm	1000



Protective shell – the ideal packaging solution for micro drills and precision tools

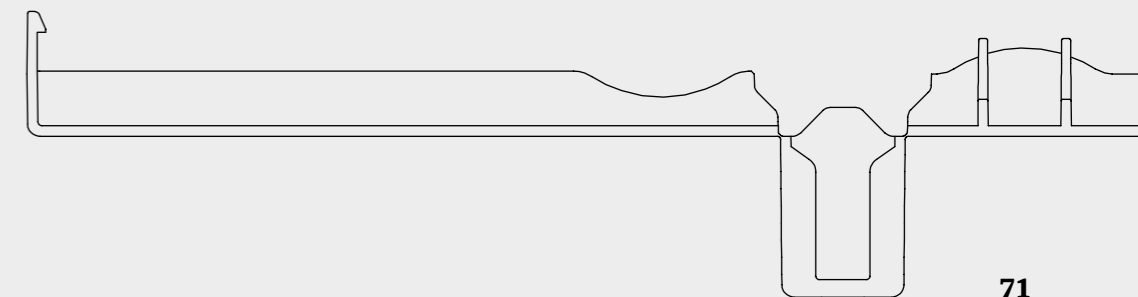

TopPackXLine

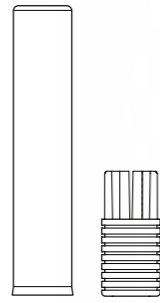

Plastic packaging tubes for extra long solid carbide drills

- patented shankholding system and longer plug size offer optimum fit of the tool
- ergonomic shape plus incorporated grooves provide grip for easy opening
- in combination with a central support perfect for extreme drill lengths up to 765 mm
- the optional middle part in combination with the adapter ensures central positioning and safe storage of the drill
- reclosable and reusable added value
- attractive design
- optimum visibility of content
- sturdy, oil, and moisture resistant



PACKAGING

All parts are packed separately in individual cartons



MATERIAL

- Outer part: PVC
- Base plug: Polyethylene (PE)
- Middle part: PVC
- Middle part adapter: Polypropylene (PP)



COLORS

- Outer part and middle part in clear, base plug and middle part adapter in a variety of attractive standard colors



ACCESSORIES

- TopPack Adaptor cap
- ProtectivCap (see page 176)

USABLE LENGTHS

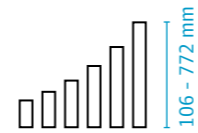

SHANK DIAM.

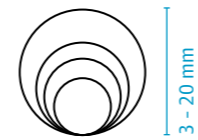

STANDARD COLORS



Product Range

Article	Part type	Dia-meter	Shank diam.	Inner length	PU	Article	Part type	Dia-meter	Shank diam.	Inner length	PU
TPKXL 13x40-3/1 I	base plug	13mm	3mm	40mm	1000	TPKXL 18x50-10/1 I	base plug	18mm	10mm	50mm	1000
TPKXL 13x40-4/1 I	base plug	13mm	4mm	40mm	1000	TPKXL 18x50-11/1 I	base plug	18mm	11mm	50mm	1000
TPKXL 13x40-5/1 I	base plug	13mm	5mm	40mm	1000	TPKXL 18x50-12/1 I	base plug	18mm	12mm	50mm	1000
TPKXL 13x40-6/1 I	base plug	13mm	6mm	40mm	1000	TPKXL 18x50-13/1 I	base plug	18mm	13mm	50mm	1000
TPKXL 13x40-7/1 I	base plug	13mm	7mm	40mm	1000	TPKXL 18x50-14/1 I	base plug	18mm	14mm	50mm	1000
TPKXL 13x40-8/1 I	base plug	13mm	8mm	40mm	1000	TPKXL 18x50-16/1 I	base plug	18mm	16mm	50mm	1000
TPKXL 18x50-6/1 I	base plug	18mm	6mm	50mm	1000	TPKXL 26x50-16/1 I	base plug	26mm	16mm	50mm	1000
TPKXL 18x50-8/1 I	base plug	18mm	8mm	50mm	1000	TPKXL 26x50-18/1 I	base plug	26mm	18mm	50mm	1000
TPKXL 18x50-9/1 I	base plug	18mm	9mm	50mm	1000	TPKXL 26x50-20/1 I	base plug	26mm	20mm	50mm	1000

Article	Part type	Ø	Inner length	Suitable base plug / middle part	Usable length	PU
TPKXL 13x108 A	outer part	13mm	108mm	TPKXL 13x40	106mm / 112mm / 125mm	340
TPKXL 13x140 A	outer part	13mm	140mm	TPKXL 13x40	138mm / 144mm / 157mm	340
TPKXL 13x168 A	outer part	13mm	168mm	TPKXL 13x40	166mm / 172mm / 185mm	340
TPKXL 13x180 A	outer part	13mm	180mm	TPKXL 13x40	178mm / 184mm / 197mm	340
TPKXL 13x205 A	outer part	13mm	205mm	TPKXL 13x40	203mm / 207mm / 222mm	340
TPKXL 13x238 A	outer part	13mm	238mm	TPKXL 13x40	236mm / 240mm / 255mm	340
TPKXL 13x260 A	outer part	13mm	260mm	TPKXL 13x40	258mm / 262mm / 277mm	340
TPKXL 13x338 A	outer part	13mm	338mm	TPKXL 13x40	335mm / 340mm / 355mm	340
TPKXL 18x160 A	outer part	18mm	160mm	TPKXL 18x50	184mm	340
	middle part	18mm	145mm	TPKXL 18x145 M	336mm	360
	middle part	18mm	200mm	TPKXL 18x200 M	391mm	270
	middle part	18mm	285mm	TPKXL 18x285 M	476mm	270
	middle part	18mm	410mm	TPKXL 18x410 M	601mm	220
TPKXL 18x186 A	outer part	18mm	186mm	TPKXL 18x50	210mm	340
	middle part	18mm	145mm	TPKXL 18x145 M	362mm	360
	middle part	18mm	200mm	TPKXL 18x200 M	417mm	270
	middle part	18mm	285mm	TPKXL 18x285 M	502mm	270
	middle part	18mm	410mm	TPKXL 18x410 M	627mm	220
TPKXL 18x215 A	outer part	18mm	215mm	TPKXL 18x50	239mm	340
	middle part	18mm	200mm	TPKXL 18x200 M	446mm	270
	middle part	18mm	285mm	TPKXL 18x285 M	531mm	270
	middle part	18mm	410mm	TPKXL 18x410 M	656mm	220
TPKXL 18x243 A	outer part	18mm	243mm	TPKXL 18x50	267mm	267
TPKXL 18x271 A	outer part	18mm	271mm	TPKXL 18x50	295mm	340
	middle part	18mm	285mm	TPKXL 18x285 M	587mm	270
	middle part	18mm	410mm	TPKXL 18x410 M	712mm	220
TPKXL 18x331 A	outer part	18mm	331mm	TPKXL 18x50	355mm	340
	middle part	18mm	410mm	TPKXL 18x410 M	772mm	220
TPKXL 18x431 A	outer part	18mm	431mm	TPKXL 18x50	455mm	340
TPKXL 18x431/2 A*	outer part	18mm	431mm	TPKXL 18x50	455mm	340
TPKXL 18x511 A	outer part	18mm	511mm	TPKXL 18x50	535mm	85
TPKXL 26x96 A	outer part	26mm	96mm	TPKXL 26x50	121mm	340
TPKXL 26x136 A	outer part	26mm	136mm	TPKXL 26x50	161mm	170
TPKXL 26x190 A	outer part	26mm	190mm	TPKXL 26x50	215mm	170
TPKXL 26x226 A	outer part	26mm	226mm	TPKXL 26x50	251mm	170
TPKXL 26x240 A	outer part	26mm	240mm	TPKXL 26x50	265mm	170
TPKXL 26x291 A	outer part	26mm	291mm	TPKXL 26x50	316mm	85

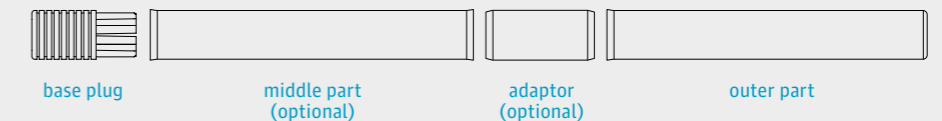

Always one length ahead – the packaging tube with a longer plug size for extra-long drills

TopPack XPress

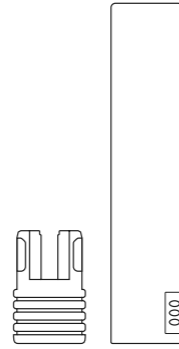

High quality single piece packaging with XPress shankholding system. Ideal for precision shank tools such as solid carbide cutters and drills

- XPress plug design for simple and secure loading/removal of tool
- diagonally arranged clamping webs in the mounting base ensure perfect hold
- user-friendly function ensures easier and safer handling of sensitive and sharp-edged cutting tools
- grooves in side of plug assist easy opening/closing
- used in conjunction with end caps increases tool holding and gives extra protection of delicate tools
- outers click securely into place with ratchet mechanism
- durable and reusable
- sturdy, oil, and moisture resistant



PACKAGING

Outer parts and inner parts are packed separately in individual cartons



MATERIAL

- Outer part: Polypropylene (PP)
- Base plug: Polyethylene (PE)



COLORS

- Outer part in transparent
- Base plug in various attractive standard colors



ACCESSORIES

- TopPack Adaptor Cap
- ProtectiveCap (see page 176)
- Protective Sleeves (see page 184)
- TopPack FiveFrame (see page 188)

USABLE LENGTHS

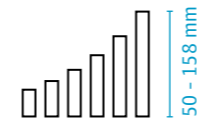

SHANK DIAM.



STANDARD COLORS



Product Range

Base plug

Article	Part type	Diam.	Shank diam.	Shank diam. (in.)	Inner length	PU
TPKXP 8x18-2/1 I	base plug	8mm	2mm		18mm	1000
TPKXP 8x18-2.35/1 I	base plug	8mm	2.35mm		18mm	1000
TPKXP 8x18-3/1 I	base plug	8mm	3mm		18mm	1000
TPKXP 8x18-1/8"/1 I	base plug	8mm	3.175mm	1/8"	18mm	1000
TPKXP 8x18-4/1 I	base plug	8mm	4mm		18mm	1000
TPKXP 8x18-3/16"/1 I	base plug	8mm	4.762mm	3/16"	18mm	1000
TPKXP 8x18-5/1 I	base plug	8mm	5mm		18mm	1000
TPKXP 8x18-6/1 I	base plug	8mm	6mm		18mm	1000
TPKXP 8x18-1/4"/1 I	base plug	8mm	6.35mm	1/4"	18mm	1000
TPKXP 8x18-7/1 I	base plug	8mm	7mm		18mm	1000
TPKXP 8x18-8/1 I	base plug	8mm	8mm		18mm	1000
TPKXP 13x25-2.35/1 I	base plug	13mm	2.35mm		25mm	1000
TPKXP 13x25-3/1 I	base plug	13mm	3mm		25mm	1000
TPKXP 13x25-4/1 I	base plug	13mm	4mm		25mm	1000
TPKXP 13x25-5/1 I	base plug	13mm	5mm		25mm	1000
TPKXP 13x25-6/1 I	base plug	13mm	6mm		25mm	1000
TPKXP 13x25-1/4"/1 I	base plug	13mm	6.35mm	1/4"	25mm	1000
TPKXP 13x25-7/1 I	base plug	13mm	7mm		25mm	1000
TPKXP 13x25-8/1 I	base plug	13mm	8mm		25mm	1000
TPKXP 13x25-9/1 I	base plug	13mm	9mm		25mm	1000
TPKXP 13x25-3/8"/1 I	base plug	13mm	9.525mm	3/8"	25mm	1000
TPKXP 13x25-10/1 I	base plug	13mm	10mm		25mm	1000
TPKXP 13x25-7/16"/1 I	base plug	13mm	11.11mm	7/16"	25mm	1000
TPKXP 13x25-12/1 I	base plug	13mm	12mm		25mm	1000
TPKXP 13x25-1/2"/1 I	base plug	13mm	12.7mm	1/2"	25mm	1000
TPKXP 18x34-9/1 I	base plug	18mm	9mm		34mm	250
TPKXP 18x34-12/1 I	base plug	18mm	12mm		34mm	250
TPKXP 18x34-13/1 I	base plug	18mm	13mm		34mm	250
TPKXP 18x34-14/1 I	base plug	18mm	14mm		34mm	250
TPKXP 18x34-15/1 I	base plug	18mm	15mm		34mm	250
TPKXP 18x34-9/16"/1 I	base plug	18mm	14.287mm	9/16"	34mm	250
TPKXP 18x34-5/8"/1 I	base plug	18mm	15.875mm	5/8"	34mm	250
TPKXP 18x34-16/1 I	base plug	18mm	16mm		34mm	250
TPKXP 20x40-18/1 I	base plug	20mm	18mm		40mm	250
TPKXP 20x40-3/4"/1 I	base plug	20mm	19.05mm	3/4"	40mm	250
TPKXP 20x40-20/1 I	base plug	20mm	20mm		40mm	250

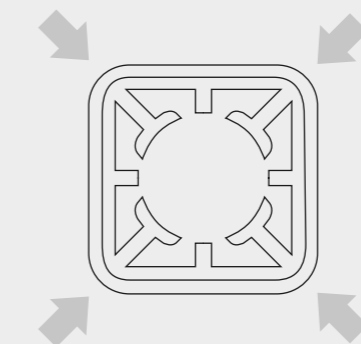

Base plug



A secure grip with an attractive design – to ensure precision shank tools are optimally protected

Product Range



PACKAGING

Outer parts and inner parts are packed separately in individual cartons



MATERIAL

- Outer part: Polypropylene (PP)
- Base plug: Polyethylene (PE)



COLORS

- Outer part in transparent
- Base plug in various attractive standard colors



ACCESSORIES

- TopPack Adaptor Cap
- ProtectiveCap (see page 176)
- Protective Sleeves (see page 184)
- TopPack FiveFrame (see page 188)

USABLE LENGTHS

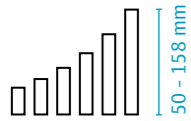

SHANK DIAM.

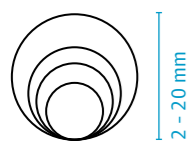

STANDARD COLORS



Outer part

Article	Part type	Diameter	Inner length	Suitable base plug	Usable length	PU
TPK 8x42 A	outer part	8mm	42mm	TPKXP 8	50	1000
TPK 8x52 A	outer part	8mm	52mm	TPKXP 8	60	1000
TPK 8x70 A	outer part	8mm	70mm	TPKXP 8	77	1000
TPK 8x85/2 A*	outer part	8mm	85mm	TPKXP 8	92	2300
TPK 8x97 A	outer part	8mm	97mm	TPKXP 8	105	1000
TPK 8x97/2 A*	outer part	8mm	97mm	TPKXP 8	105	1000
TPK 13x56 A	outer part	13mm	56mm	TPKXP 13	66	500
TPK 13x74 A	outer part	13mm	74mm	TPKXP 13	84	500
TPK 13x88 A	outer part	13mm	88mm	TPKXP 13	98	500
TPK 13x97 A	outer part	13mm	97mm	TPKXP 13	108	500
TPK 13x110 A	outer part	13mm	110mm	TPKXP 13	120	500
TPK 18x83 A	outer part	18mm	83mm	TPKXP 18	98	500
TPK 18x113 A	outer part	18mm	113mm	TPKXP 18	129	500
TPK 18x130 A	outer part	18mm	130mm	TPKXP 18	144	250
TPK 18x145/2 A*	outer part	18mm	145mm	TPKXP 18	158	500
TPK 20x89 A	outer part	20mm	89mm	TPKXP 20	108	250
TPK 20x130 A	outer part	20mm	130mm	TPKXP 20	149	250

* Outer part in PVC

Accessories

Article	Part type	Suitable for	Shank diam.	PU
TKA 8-3/4	adaptor cap	TPK Ø 8	3 - 5mm	1000
TKA 13-3/4	adaptor cap	TPK Ø 13	3 - 6mm	1000
TKA 13-6/4	adaptor cap	TPK Ø 13	6 - 8mm	1000
TKA 18-8/4	adaptor cap	TPK Ø 18	8 - 14mm	1000
TKA 20-10/4	adaptor cap	TPK Ø 20	10 - 16mm	500
TKA 26-16/4	adaptor cap	TPK Ø 26	16 - 22mm	300
TKA 32-20/4	adaptor cap	TPK Ø 32	20 - 28mm	300





TwistPackPlus

The ultimate plastic packaging tube is here

The TwistPack Plus is the new generation of TwistPack from rose plastic – probably the most used packaging tube in the world.

The TwistPack Plus from rose plastic – even more capable, even simpler, even greater protection.

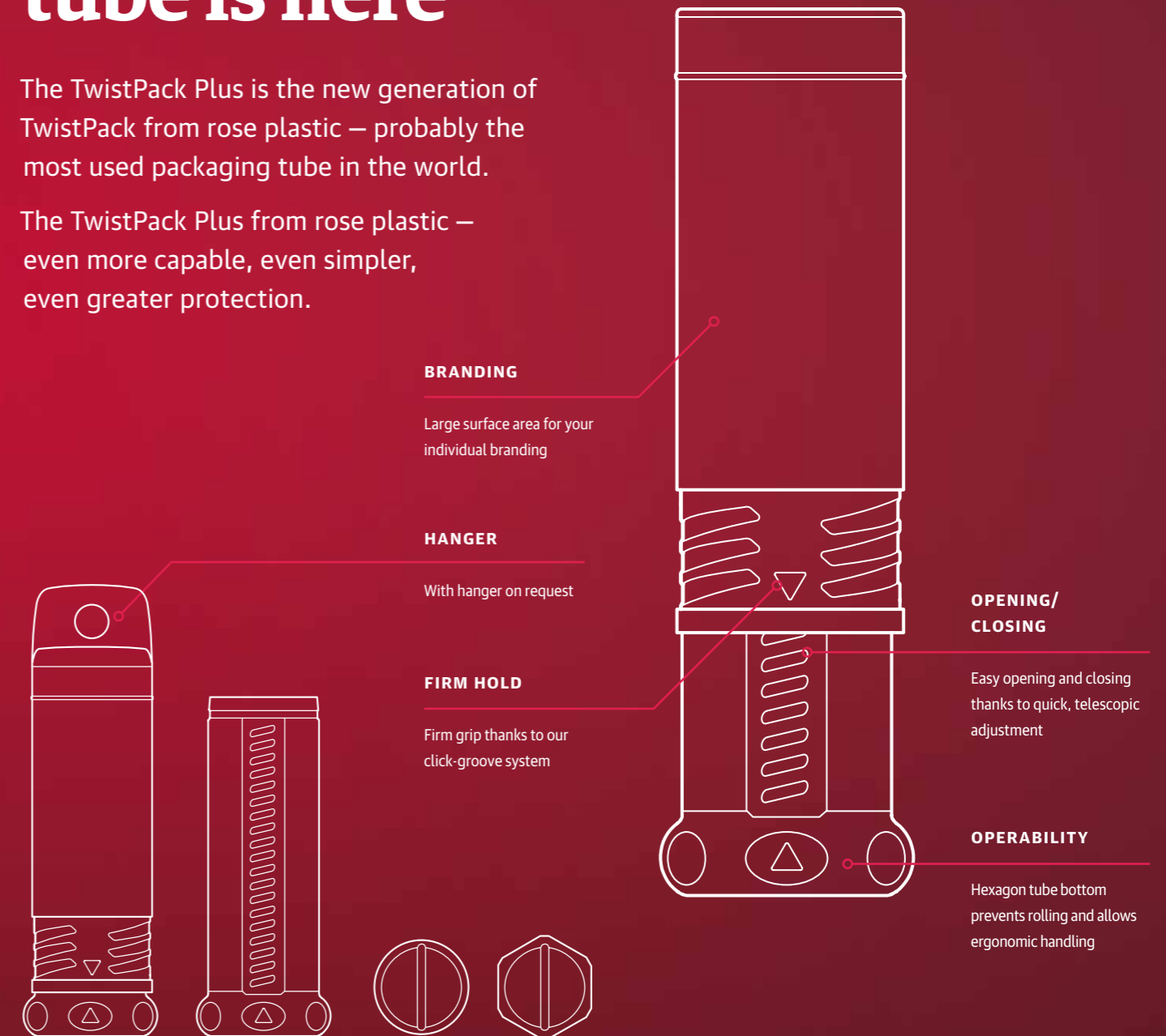

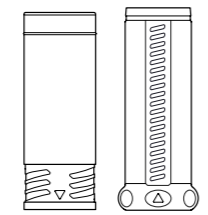

TwistPack Plus

More safety. More efficiency. The new generation of TwistPack packaging tubes convince with user-friendly twist lock closure

- maximum flexibility through universal length adjustment
- optimal product protection
- easy opening and closing through telescopic adjustment
- firm hold force through our click groove system
- large surface area for your individual branding
- hexagon tube bottom prevents rolling
- durable and reusable
- sturdy, oil, and moisture resistant



Need packaging for elongated or cylindrical products? Meet the solution. Simply adjust the length, turn – et voila!



PACKAGING
Outer parts and inner parts are packed separately in individual cartons;
TX 85 and TX 105 outer parts and inner parts are packed assembled



MATERIAL

- Polyethylene (PE)
- Polypropylene (PP)
- Polyvinylchloride (PVC)
- Recycled plastic
- Bio plastic



COLORS

- Depending on the material transparent, natural or in various attractive standard colors or two-color



ACCESSORIES

- Foam inserts (see page 180)
- With hanger on request

USABLE LENGTHS

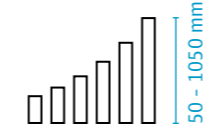

Ø DIAMETER

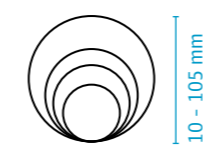

STANDARD COLORS

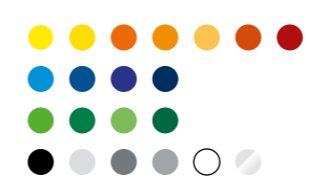

Product Range

Article	Inner diam.	Usable length	PU	Article	Inner diam.	Usable length	PU
TX 10 050	10mm	50 - 70mm	2000	TX 35 050	35mm	50 - 60mm	450
TX 10 080	10mm	80 - 120mm	1700	TX 35 060	35mm	60 - 80mm	600
TX 10 120	10mm	120 - 200mm	1000	TX 35 080	35mm	80 - 120mm	550
TX 13 050	13mm	50 - 70mm	2100	TX 35 120	35mm	120 - 200mm	350
TX 13 080	13mm	80 - 120mm	1300	TX 35 200	35mm	200 - 350mm	250
TX 13 120	13mm	120 - 200mm	1700	TX 35 350	35mm	350 - 620mm	150
TX 13 200	13mm	200 - 350mm	1350	TX 35 500*	35mm	500 - 750mm	250
TX 16 050	16mm	50 - 70mm	1500	TX 35 700*	35mm	700 - 1050mm	150
TX 16 080	16mm	80 - 120mm	2000	TX 40 050	40mm	50 - 60mm	700
TX 16 120	16mm	120 - 200mm	1200	TX 40 060	40mm	60 - 80mm	600
TX 16 200	16mm	200 - 350mm	1000	TX 40 080	40mm	80 - 120mm	450
TX 16 350	16mm	350 - 620mm	500	TX 40 120	40mm	120 - 200mm	270
TX 16 410	16mm	410 - 770mm	500	TX 40 200	40mm	200 - 350mm	208
TX 20 050	20mm	50 - 70mm	950	TX 40 350	40mm	350 - 620mm	120
TX 20 080	20mm	80 - 120mm	1500	TX 45 050	45mm	50 - 60mm	280
TX 20 120	20mm	120 - 200mm	900	TX 45 060	45mm	60 - 80mm	500
TX 20 200	20mm	200 - 350mm	700	TX 45 080	45mm	80 - 120mm	300
TX 22 050	22mm	50 - 60mm	1000	TX 45 120	45mm	120 - 200mm	250
TX 22 080	22mm	80 - 120mm	1300	TX 45 200	45mm	200 - 350mm	180
TX 22 120	22mm	120 - 200mm	650	TX 45 350	45mm	350 - 620mm	100
TX 22 200	22mm	200 - 350mm	600	TX 45 500*	45mm	500 - 750mm	180
TX 22 350	22mm	350 - 620mm	390	TX 45 700*	45mm	700 - 1050mm	100
TX 22 410	22mm	410 - 770mm	300	TX 50 050	50mm	50 - 60mm	400
TX 22 500*	22mm	500 - 750mm	600	TX 50 060	50mm	60 - 80mm	350
TX 22 700*	22mm	700 - 1050mm	390	TX 50 080	50mm	80 - 120mm	300
TX 24 050	24mm	50 - 60mm	810	TX 50 120	50mm	120 - 200mm	190
TX 24 080	24mm	80 - 120mm	1000	TX 50 200	50mm	200 - 350mm	140
TX 24 120	24mm	120 - 200mm	600	TX 50 350	50mm	350 - 620mm	80
TX 24 200	24mm	200 - 350mm	500	TX 55 050	55mm	50mm	400
TX 26 050	26mm	50 - 60mm	800	TX 55 060	55mm	60 - 80mm	200
TX 26 080	26mm	80 - 120mm	900	TX 55 080	55mm	80 - 120mm	200
TX 26 120	26mm	120 - 200mm	550	TX 55 120	55mm	120 - 200mm	160
TX 26 200	26mm	200 - 350mm	450	TX 55 200	55mm	200 - 350mm	110
TX 26 350	26mm	350 - 620mm	260	TX 55 350	55mm	350 - 620mm	68
TX 26 410	26mm	410 - 770mm	200	TX 65 050	65mm	50mm	220
TX 26 500*	26mm	500 - 750mm	450	TX 65 060	65mm	60 - 80mm	220
TX 26 700*	26mm	700 - 1050mm	260	TX 65 080	65mm	80 - 120mm	170
TX 28 050	28mm	50 - 60mm	600	TX 65 120	65mm	120 - 200mm	128
TX 28 080	28mm	80 - 120mm	900	TX 65 200	65mm	200 - 350mm	86
TX 28 120	28mm	120 - 200mm	550	TX 65 350	65mm	350 - 620mm	46
TX 28 200	28mm	200 - 350mm	405	TX 85 080	85mm	80 - 100mm	100
TX 30 050	30mm	50 - 60mm	1000	TX 85 120	85mm	120 - 180mm	65
TX 30 080	30mm	80 - 120mm	750	TX 85 200	85mm	200 - 350mm	36
TX 30 120	30mm	120 - 200mm	450	TX 85 350	85mm	350 - 550mm	20
TX 30 200	30mm	200 - 350mm	320	TX 85 550	85mm	550 - 1000mm	18
TX 30 350	30mm	350 - 620mm	200	TX 105 080	105mm	80 - 100mm	72
TX 30 410	30mm	410 - 770mm	160	TX 105 120	105mm	120 - 180mm	48
				TX 105 200	105mm	200 - 350mm	30

*assembled from three parts (two outer parts and one middle part)



VarioBox

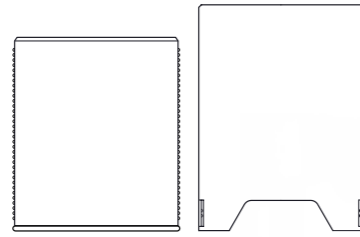

Multi-compartment packaging system for shank tools and longer precision parts (e.g. twist drills, taps, milling cutters etc.)

- packaging with 5 or 10 compartments for twist drills according to DIN 1897, 338, 339, 334 etc.
- variable length adjustment
- speedy efficient packaging
- customized printing possible
- excellent for stacking and storage
- durable and reusable

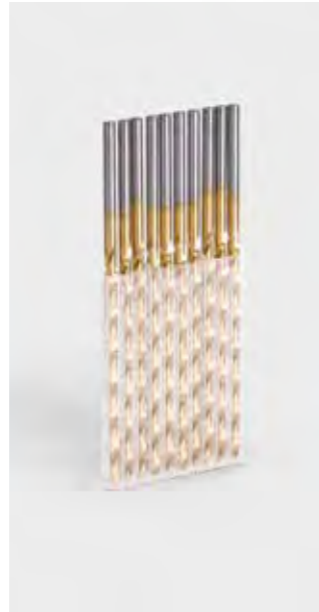

The ideal way to protect shank tools and longer precision parts – safe and simple



PACKAGING
Outer parts and inner parts are packed separately in individual cartons



MATERIAL
- Polypropylene (PP)
- Recycled plastic



COLORS
- PP transparent or in various attractive standard colors



ACCESSORIES
- With hanger on request

USABLE LENGTHS

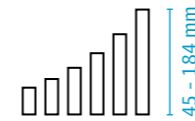

DIAM. UNIT

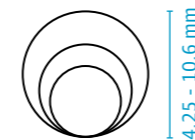

STANDARD COLORS



Product Range

Article	Number of units	Inner diam. of unit	Usable length adjustable	PU
VB 4x 45	10	4.25mm	45 - 70mm	1000
VB 4x 72	10	4.25mm	72 - 120mm	500
VB 6x 52	10	6.2mm	52 - 84mm	350
VB 6x 90	10	6.2mm	90 - 148mm	250
VB 10x 80	10	10.6mm	80 - 134mm	200
VB 10x105	5	10.6mm	105 - 184mm	300

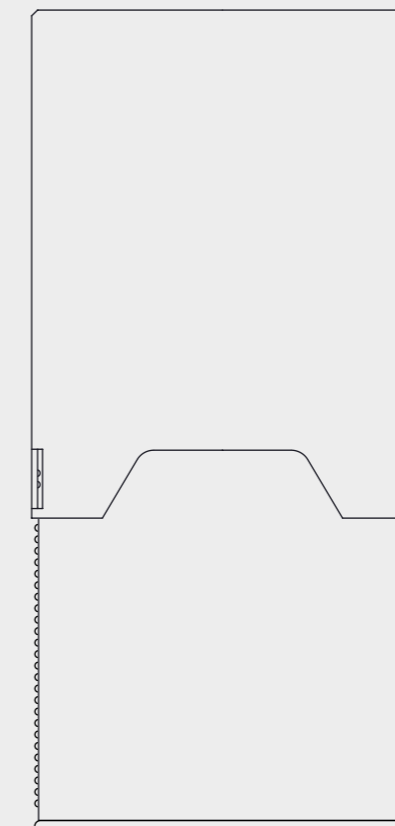

VarioPackNT

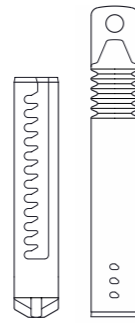

Plastic packaging tubes with dual "bayonet-style" closure for maximum holding force. Ideal packaging for heavy masonry drills

- attractive product presentation due to modern design, and transparency of at least one part of the tube
- dual "bayonet-style" closure holds heavy tools securely in place
- variable length adjustment
- shock absorbing "concertina" tube walls close down firmly on each end of the tool, preventing any movement of the tool within the packaging
- perfect centering of drills
- special interior design of the inner tube section provides additional protection for the drill point
- sturdy integral hanger
- lends itself to automated packaging



PACKAGING
Outer parts and inner parts are packed separately in individual cartons



MATERIAL
- Polyvinylchloride (PVC)



COLORS
- PVC clear or in various attractive standard colors

USABLE LENGTHS

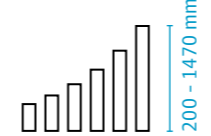

DIAMETER

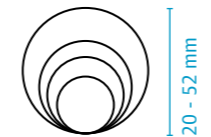

STANDARD COLORS



Product Range

Article	Hanger	Inner diam.	Usable length adjustable	PU
VPNT-A 20 200	round hole hanger	20mm	200 - 250mm	1000
VPNT-A 20 280	round hole hanger	20mm	280 - 350mm	500
VPNT-A 20 300	round hole hanger	20mm	300 - 470mm	500
VPNT-A 20 500	round hole hanger	20mm	500 - 670mm	250
VPNT-A 26 200	euro hole hanger	26mm	200 - 260mm	400
VPNT-A 26 300	euro hole hanger	26mm	300 - 350mm	200
VPNT-A 26 350	euro hole hanger	26mm	350 - 450mm	200
VPNT-A 26 450	euro hole hanger	26mm	450 - 490mm	200
VPNT-A 26 460	euro hole hanger	26mm	460 - 600mm	200
VPNT-A 26 540	euro hole hanger	26mm	540 - 820mm	200
VPNT-A 26 630	euro hole hanger	26mm	630 - 950mm	100
VPNT-A 26 1030	euro hole hanger	26mm	1030 - 1350mm	100
VPNT-A 32 200	euro hole hanger	32mm	200 - 259mm	200
VPNT-A 32 280	euro hole hanger	32mm	280 - 350mm	200
VPNT-A 32 340	euro hole hanger	32mm	340 - 500mm	200
VPNT-A 32 500	euro hole hanger	32mm	500 - 690mm	100
VPNT-A 32 580	euro hole hanger	32mm	580 - 950mm	100
VPNT-A 32 690	euro hole hanger	32mm	690 - 900mm	100
VPNT-A 32 1100	euro hole hanger	32mm	1100 - 1470mm	100
VPNT-A 42 490	euro hole hanger	42mm	490 - 620mm	50
VPNT-A 42 620	euro hole hanger	42mm	620 - 750mm	50
VPNT-A 42 650	euro hole hanger	42mm	650 - 950mm	50
VPNT-A 42 1060	euro hole hanger	42mm	1060 - 1350mm	50
VPNT-A 52 280	euro hole hanger	52mm	280 - 340mm	50
VPNT-A 52 370	euro hole hanger	52mm	370 - 510mm	50
VPNT-A 52 520	euro hole hanger	52mm	520 - 840mm	50
VPNT-A 52 540	euro hole hanger	52mm	540 - 700mm	50
VPNT-A 52 900	euro hole hanger	52mm	900 - 1200mm	25

Euro hole hanger

Round hole hanger

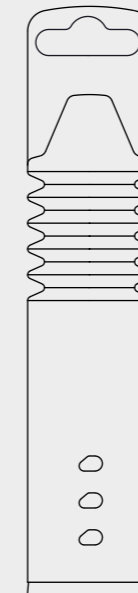

Better safe than sorry – the perfect packaging for heavy masonry drills thanks to a dual “bayonet-style” closure



VarioPack VP and VPN

Telescopic plastic drawing tubes for storage and transportation of drawings, blueprints, posters, documents and much more

VarioBox VP 1

- with telescopic inners ratchet mechanism for variable length adjustment
- all sizes extendable by 400 mm
- screw cap for secure closure and quick access
- additional transparent cover for cap for insertion of label, name and address etc.
- carrying strap length adjustable
- can be printed with logo or advertising slogan
- sturdy, oil, and moisture resistant



1



VarioBox VPN 2

- 2-part version, variable length adjustment, economical
- simple cord system with name plate



2



PACKAGING
Packed assembled



- MATERIAL**
- 1 **VarioPack VP**
 - Tube, rings and clips: Polyethylene (PE)
 - Cover: Polypropylene (PP)
 - Recycled plastic
 - Bio plastic
 - 2 **VarioPack VPN**
 - Polypropylene (PP)
 - Recycled plastic
 - Bio plastic



- COLORS**
- 1 **VarioPack VP**
 - Tube in black; rings and clips in red
 - Please enquire for other colors or color combinations
 - 2 **VarioPack VPN**
 - Tube in red, blue or in various attractive standard colors
 - Cord and name plate in silver



- ACCESSORIES**
- 2 **VarioPack VPN**
 - Cord, name plate and assembling instruction are enclosed loosely

USABLE LENGTHS

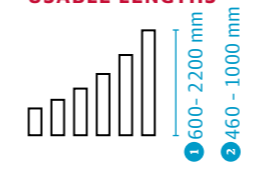

DIAMETER

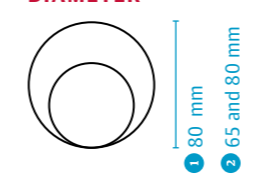

STANDARD COLORS

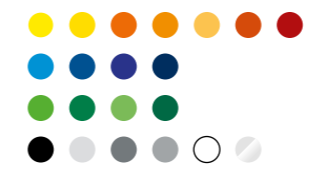

Product Range

1 VarioPack VP

Article	Inner diam.	Usable length adjustable	PU
VP 80 600/1 K	80mm	600 - 1000mm	25
VP 80 800/6 K	80mm	800 - 1200mm	15
VP 80 1200/10 K	80mm	1200 - 1600mm	12
VP 80 1400/12 K	80mm	1400 - 1800mm	10
VP 80 1800/13 K	80mm	1800 - 2200mm	8

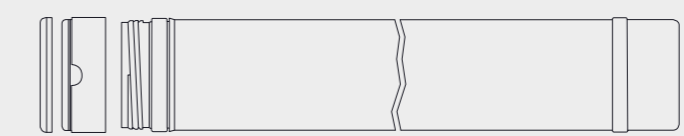

2 VarioPack VPN

Article	Inner diam.	Usable length adjustable	PU
VPN 65 460/1 K	65mm	460 - 680mm	32
VPN 80 600/16 K	80mm	600 - 1000mm	25



Who says it's going down the tube? Safe storage for your drawings, blueprints, posters and documents

Plastic boxes

Boxes for virtually things in particular.

anything. And for some

Our high-quality plastic boxes are in demand as practical and safe packaging for cutting tools as well as other industrial components. They are the first choice of tool retailers and hardware stores – not least thanks to their suitability as high-quality promotional and sales packaging.

Uni Box

Plastic storage boxes with hinged lid and secure closure
more on page 114



Consumer Box

Plastic boxes with hinged lid and integrated latch
more on page 92



Bit Pack

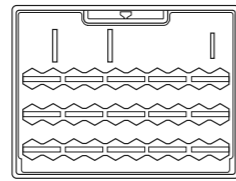

Modular design bit packaging product

BitPack 1

- flexible insert available for 6, 9 or 11 bits plus bit holder
- 3-part with integral "anti-theft" feature



BitPack 30

- holds 30 bits plus a bit holder
- 3-part with integral "anti-theft" feature



PACKAGING

Cover and base are packed separately in individual cartons



MATERIAL

- ABS



COLORS

- Cover in clear; base and insert in various attractive standard colors



ACCESSORIES

- Hanger

HEIGHTS

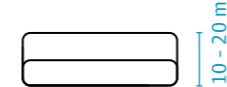

DIMENSION

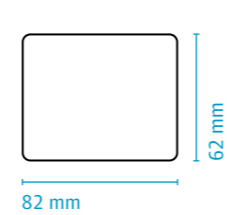

STANDARD COLORS



Product Range

1 BitPack

Article	Version	Dimension	PU
Bit 60 x 80 x 10/1 A	BitPack cover	62x82x10mm	500
Bit 60 x 80 x 10/1 I	BitPack base for 60mm bit holder	62x82x10mm	500
Bit 60 x 80 x 10/3 I	BitPack base for 55mm bit holder	62x82x10mm	500
Bit 60 x 80 x 10/4 I	BitPack base with compartment for bit holder	62x82x10mm	500
Bit 60 x 80 x 10/5 I	BitPack base with bit holder up to 60mm	62x82x10mm	500
Bit 6/1 E	6 part insert for UT		500
Bit 9/1 E	9 part insert for UT		500
Bit 11/1 E	11 part insert for UT		500

2 BitPack 30

Article	Version	Dimension	PU
Bit 60 x 80 x 10/1 A	BitPack cover	62x82x10mm	500
Bit 60 x 80 x 20/1 I	BitPack 30 base	62x82x20mm	500
Bit 30/1 E	30 part insert for 60mm bit holder		250
Bit 30/3 E	30 part insert for 55mm bit holder		250

3 Hanger

Article	Version	Dimension	PU
Bit-Hanger 22 x 50/1	euro hole hanger	22x50mm	3000
Bit-Hanger 53 x 83/1	euro hole hanger (can be labelled)	53x83mm	1500

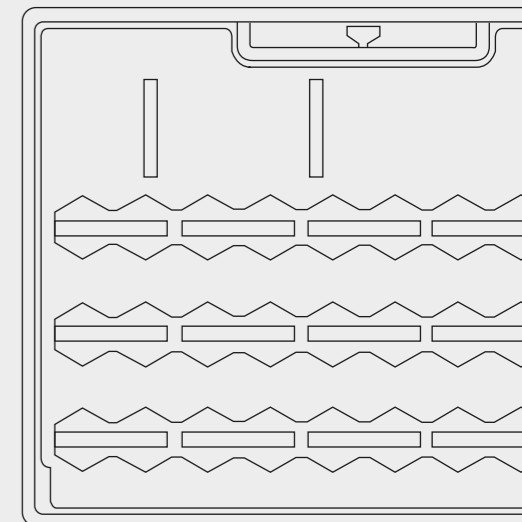

This practical set packaging ensures your "little ones" always stay together

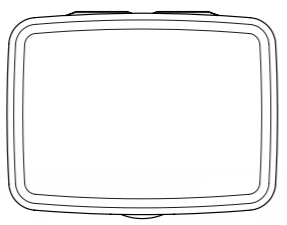

Consumer Box

Plastic boxes with hinged lid and integrated latch

- high quality image
- universal application
- polished lid surface provides high transparency for product visibility
- latch integrated into box contours
- durable hinges
- transparent, solid or translucent colored boxes offer numerous options for diversification
- excellent surface for printing and labeling



Simply brilliant, brilliantly simple: This high-quality plastic box with integrated latch and polished lid surface is the perfect sales packaging



PACKAGING
Carton



MATERIAL
- Polypropylene (PP)
- Recycled plastic



COLORS
- Depending on the material transparent, natural or in various attractive standard colors



ACCESSORIES
- With hanger on request

HEIGHTS



DIMENSION

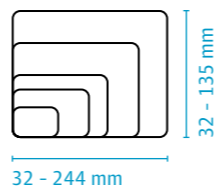

STANDARD COLORS



Product Range

Article	Version	Description	Inner length	Inner width	Inner height	PU
CB 34x34x8/1	1		32mm	32mm	8mm	1000
CB 56x42x10/1	1		55mm	39mm	10mm	400
CB 68x50x13/1	1		66mm	47mm	13mm	470
CB 95x70x17/1	1		92mm	65mm	17mm	340
CB 95x70x17/2	2	w/ insert for hanger	92mm	65mm	17mm	340
CB 95x70x17/3	3	w/ flat lid	92mm	65mm	17mm	340
CB 115x85x26/1	1		111mm	78mm	26mm	172
CB 138x102x30/1	1		134mm	95mm	30mm	88
CB 150x50x30/1	1		147mm	44mm	29mm	180
CB 150x50x30/2	2	w/ insert for hanger	147mm	44mm	29mm	180
CB 180x145x45/1	1		173mm	135mm	45mm	80
CB 246x88x20/1	1		244mm	83mm	16mm	100
CB 246x88x20/2	2	for calipers; w/ hanger insert	244mm	83mm	16mm	100
CB 246x88x20/3	3	w/ holding device for caliper	244mm	83mm	16mm	100
CB 246x88x20/4	4	w/ insert for hanger	244mm	83mm	16mm	100
CB Hanger 44x19/1	1	hanger for ConsumerBox				2000



FivePack



Multi-compartment packaging system with 5 individual detachable units for taps, burrs and shank tools

- versatile packaging combining single unit with multiple packaging
- FivePack: one-piece version with hinged lid
- FivePack Cradle: with "cradles" to support smaller diameter shanks
- user-friendly and efficient detachable units
- no packing and repacking of single items necessary
- each unit is reusable with hinged lid and snap-closure
- speedy handling
- space saving
- excellent for stacking and storage



High five! Five perfectly protected tools in one packaging solution – with individually detachable chambers



PACKAGING

Carton



MATERIAL

- Polypropylene (PP)
- Recycled plastic



COLORS

- Depending on the material transparent, natural or in various attractive standard colors



ACCESSORIES

- Foam inserts (see page 182)

USABLE LENGTHS

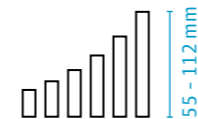

DIAMETER

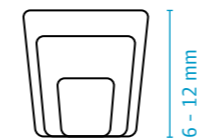

STANDARD COLORS



Product Range

FivePack

Article	Number of units	Inner diam. of unit	Inner length	PU
FP 6x55	5	6mm	55mm	650
FP 6x72	5	6mm	72mm	500
FP 6x85	5	6mm	85mm	630
FP 10x68	5	10mm	68mm	460
FP 10x84	5	10mm	84mm	380
FP 10x105	5	10mm	105mm	330
FP 12x91	5	12mm	91mm	210
FP 12x112	5	12mm	112mm	210

FivePack Cradle

Article	Number of units	Inner diam. of unit	Shank holding diam.	max. head diam.	Inner length	PU
FP-W 6x40/9	5	6mm	3.25mm	3.25mm	40mm	650
FP-W 6x55/9	5	6mm	3.25mm	6mm	55mm	650
FP-W 10x68/9	5	10mm	6.5mm	10mm	68mm	460
FP-WG 12x91/2	5	12mm	6.5mm	12mm	91mm	210



InsertBox InsertClickBox

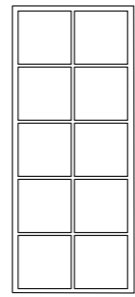

Packaging boxes for carbide inserts

- secure closure due to central fixing (InsertBox) or snap-in function (InsertClickBox) in the lid
- closing by simply pushing in or pressing on the lid
- lid slides open in either direction
- excellent for stacking and storage
- InsertClickBox including snap-in function in the lid, after opening a double chamber it snaps in at a defined point
- InsertClickBox including stacking function, for securely holding stacked boxes together, e.g. in packaging units



PACKAGING
Base and cover are packed separately in individual cartons



MATERIAL
- Polypropylene (PP)
- Recycled plastic



COLORS
- Cover in transparent, base in various attractive standard colors

DIVIDERS

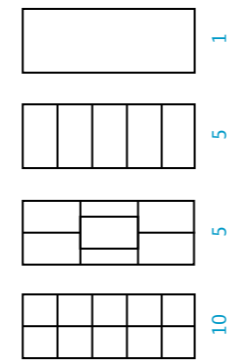

STANDARD COLORS



Product Range

InsertBox

Article	Size designation	Number of units	Inner length of unit	Inner width of unit	Inner height	PU
IB-W 10.5x5.2	1	10	10.5mm	10.5mm	5.2mm	700
IB-W 17.8x6.5	2A	10	17.8mm	17.8mm	6.5mm	1200
IB-W 17.8x8.5	2B	10	17.8mm	17.8mm	8.5mm	1200
IB-W 95.2x37.2x8.5	2C	1	95.2mm	37.2mm	8.5mm	1200
IB-W 25.7x8.2	3A	10	25.7mm	25.8mm	8.2mm	450
IB-W 25.7x12.8	3B	10	25.7mm	25.8mm	12.8mm	450
IB-W 25.7x9	3C	5	52mm	25.7mm	9mm	450
IB-W 25.5x20.5	3D	10	25.5mm	25.5mm	20.5mm	a.A.
IB-W 30.0x10.5	4A	5	30mm	30mm	10.5mm	450
IB-W 30.0x17.5x10.5	4B	10	30mm	17.5mm	10.5mm	450
IB-W 35.0x10.5	5A	5	35mm	35mm	10.5mm	380
IB-W 35.0x13.5	5B	5	35mm	35mm	13.5mm	380
IB-W 20.5x39.5x15	6	5	39.5mm	20.5mm	15mm	450

InsertClickBox

Article	Size designation	Number of units	Inner length of unit	Inner width of unit	Inner height	PU
ICB-W 17.8x6.5	2A	10	17.8mm	17.8mm	6.5mm	5000
ICB-W 95x37x6.5	2D	1	95mm	37mm	6.5mm	5000
ICB-W 25.7x8.2	3A	10	25.7mm	25.8mm	8.2mm	300



Our “division manager” offers maximum protection for sensitive carbide inserts



InsertBoxConnect

Individual packaging that can be connected to form sets. Ideal for the safe transport of high-quality indexable inserts (PCD/CBN).

- plastic box with or without center post for holding ISO indexable cutting inserts
- the center post as well as distance rings in the base and lid prevent contact of the cutting edges with the packaging
- two sizes and different holding geometries provide the optimal packaging for a wide variety of insert geometries
- in the closed box, the pin is stabilized by an additional fixation in the lid and thus remains intact even in case of heavy impacts
- the boxes can be connected to each other to form sets using a plug-in function on all sides
- interconnected boxes form a plain, continuous surface for labels and inscriptions
- secure integrated latch and hinged lid
- suitable for automated processes
- no packing and repacking of single units necessary
- sturdy, oil and moisture resistant
- sustainable, resealable, reusable and recyclable
- excellent for stacking and storage



PACKAGING
Carton



MATERIAL
- Polypropylene (PP)
- Recycled plastic



COLORS
- Depending on the material
transparent, natural or in various attractive standard colors

STANDARD COLORS



Product Range

Article	Description	Inner length	Inner width	Inner height	Diameter tool holder	Max. tool height	PU
IBC 28x25x8/1	without centering	28mm	25mm	8.5mm	-	8.4mm	440
IBC 28x25x8/2	with centering	28mm	25mm	8.5mm	2.6mm	2.6mm	440
IBC 28x25x8/3	with centering	28mm	25mm	8.5mm	3.8mm	4.9mm	440
IBC 45x42x12/1	without centering	45mm	42mm	12.5mm	-	12.4mm	540
IBC 45x42x12/2	with centering	45mm	42mm	12.5mm	3.7mm	6.4mm	540



Special protection for sensitive tools: the InsertBox Connect ensures undamaged inserts

InsertBox HighS

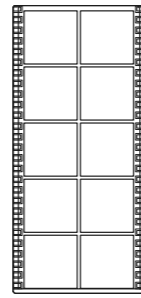

High-quality plastic packaging boxes for carbide inserts

- many packing possibilities due to the number of compartments and post to center tools
- functional and user-friendly high quality design
- clear ABS material allows product presentation
- sliding lid with ratchet mechanism and stop device
- cost-conscious solution due to long-term re-usability
- easy handling, suitable for automated loading
- excellent for stacking, additional fit through easy clamping in the cover and bottom
- customized branding or embossing of brand/logo possible
- foam pad insert to be put into cover of pack for additional protection available



PACKAGING
Base and cover are packed separately in individual cartons



MATERIAL
- Base in PS / ABS
- Cover in ABS



COLORS
- Cover in clear;
base in various attractive standard colors



ACCESSORIES
- Foam pad inserts

DIVIDERS

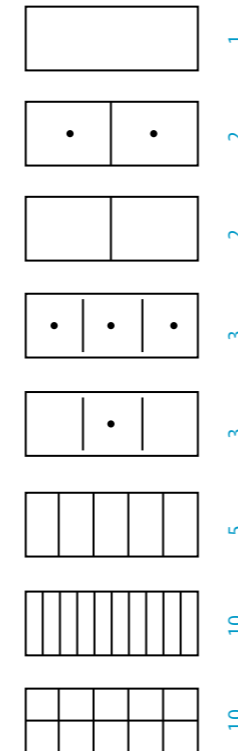

STANDARD COLORS



Product Range

InsertBox HighS

Article	Number of units	Compartment design	Inner length unit	Inner width unit	Inner height	PU
IH 31x61x10/1	1	without compartments	31mm	61.5mm	9.7mm	1200
IH 31x61x10/2	3	1 cylindrical center spigot	31mm	19.7mm	9.7mm	1200
IH 31x61x10/3	3	3 conical center spigots	31mm	19.7mm	9.7mm	1200
IH 31x61x10/4	3	3 cylindrical center spigots	31mm	19.7mm	9.7mm	1200
IH 31x61x10/5	10	longish compartments	31mm	5.2mm	10.7mm	1200
IH 31x61x10/6	2	square compartments	31mm	30.1mm	9.7mm	1200
IH 31x61x10/7	2	2 cylindrical center spigots	31mm	30.1mm	9.7mm	1200
IH 37x94x6.5/1	1	without compartments	37mm	94mm	6.5mm	780
IH 37x94x6.5/2	10	square compartments	17.7mm	17.7mm	6.5mm	780
IH 37x94x6.5/3	10	longish compartments	36.6mm	8.3mm	6.5mm	780
IH 37x94x10/1	1	without compartments	36.6mm	93.6mm	9.7 mm	
IH 37x94x10/2	2	2 cylindrical center spigots	36.6mm	46.2mm	9.7 mm	
IH 37x94x10/3	10	square compartments	17.7mm	17.7mm	9.7 mm	
IH 52x133x8.5/1	1	without compartments	52mm	133mm	8.4mm	585
IH 52x133x8.5/2	10	square compartments	25.7mm	25.7mm	8.4mm	585
IH 52x133x8.5/3	10	longish compartments	52mm	12.2mm	8.4mm	585
IH 52x133x13/1	1	without compartments	52mm	133mm	13.6mm	400
IH 52x133x13/2	10	square compartments	25.7mm	25.7mm	13.6mm	400
IH 52x133x13/3	5	longish compartments	52mm	25.5mm	13.6mm	400
IH 52x133x20/1	1	without compartments	52mm	133mm	20mm	265
IH 52x133x20/2	10	square compartments	25mm	25mm	20mm	265
IH 52x133x20/3	10	longish compartments	52mm	11.8mm	20mm	265

Foam pad inserts for InsertBox HighS

Article	Suitable for	Number of compartments	Compartment size	Outer height	PU
SE IH 31x61x10 K 1 A.	IH 31x61x10	1	38x23	10mm	5000
SE IH 31x61x10 K 2 A.	IH 31x61x10	2	20x23	10mm	5000
SE IH 37x93.5x5.5/1 K 5 A.	IH 37x94x6.5	5	15x30	5.5mm	3000
SE IH 37x93.5x5.5/2 K 10 A.	IH 37x94x6.5	10	14x15	5.5mm	3000
SE IH 37x93.5x6.5/1 K 5 A.	IH 37x94x6.5	5	15x30	6.5mm	3000
SE IH 37x93.5x6.5/2 K 10 A.	IH 37x94x6.5	10	14x15	6.5mm	3000
SE IH 52x133x8.5/1 K 10 A.	IH 52x133x8.5	10	19x20	8.5mm	3000
SE IH 52x133x13/2 A.	IH 52x133x13/2	2	46,4x46,4	10mm	3000
SE IH 52x133x13/6 A.	IH 52x133x13/6	6	30x20	10mm	3000
SE IH 52x133x13 B	IH 52x133x13/6	0	-	3mm	3000

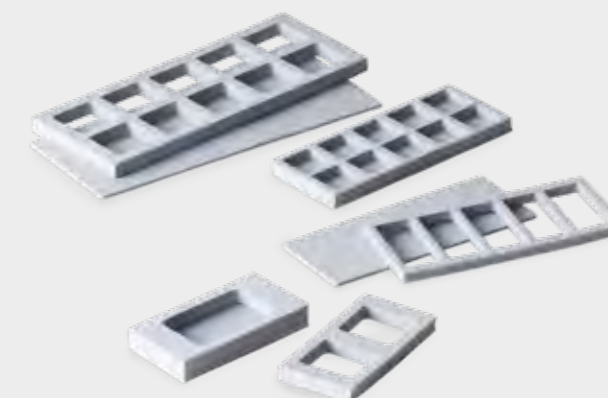

Seriously secure protection for sensitive cutting edges. One box, many variants, multiple benefits





InsertSplitBox

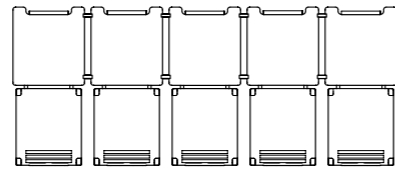

Multi-compartment packaging system for carbide inserts – one-piece version with 5 individual detachable hinged boxes

- versatile packaging combining single unit with multiple packaging
- no packing and repacking of single units necessary
- each unit is reusable with hinged lid and snap-closure
- excellent for stacking and storage

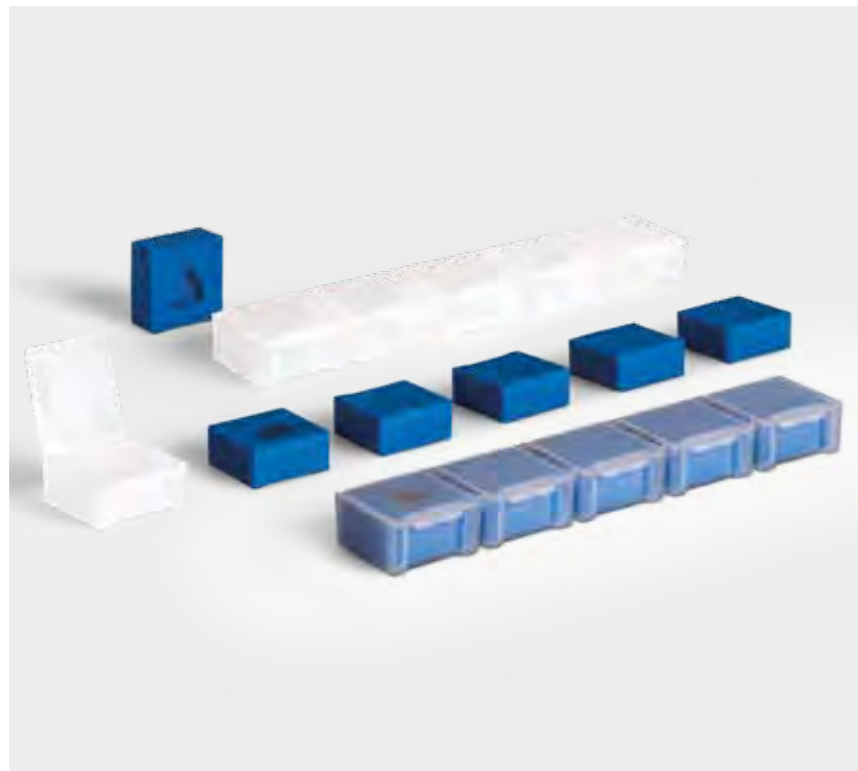
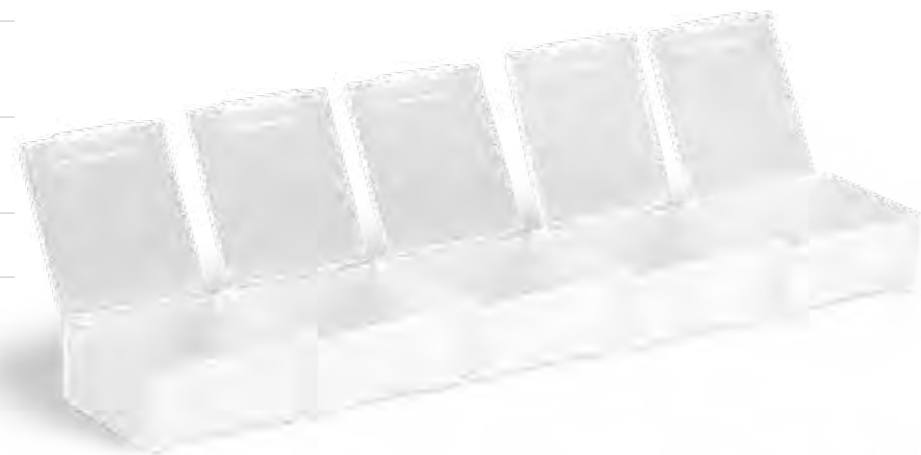

Think outside the box: This secure, multi-compartment packaging with individually detachable hinged boxes provides excellent protection for cutting inserts



PACKAGING

Carton



MATERIAL

- Polypropylene (PP)
- Recycled plastic



COLORS

- Depending on the material transparent, natural or in various attractive standard colors



ACCESSORIES

- Foam inserts (see page 180)

HEIGHTS



DIMENSIONS

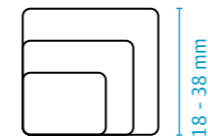

STANDARD COLORS



Product Range

Article	Number of units	Inner length unit	Inner width unit	Inner height	PU
ISB 18x18x8.5	5	18mm	18mm	8.5mm	650
ISB 28x28x12.7	5	28mm	28mm	12.7mm	200
ISB 38x38x16	5	38mm	38mm	16mm	200

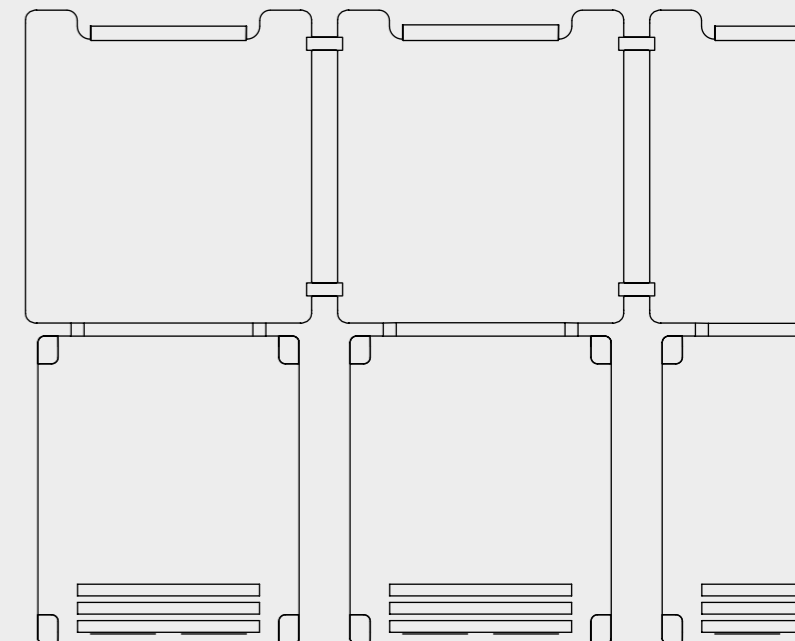

InsertSplitBox SL

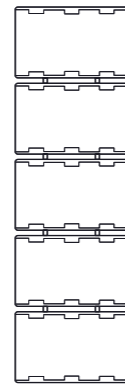

Multi-compartment packaging system for carbide inserts – two-piece version with 5 individual detachable boxes

- versatile packaging combining single unit with multiple packaging
- no packing and repacking of single units necessary
- separate highly transparent lids snap into each middle and end position and provides therefore additional protection during opening/closing
- cover slides open in either direction
- suitable for small lot sizes and equipping tool dispensers
- stackable due to the special guiding ridges
- suitable for automated loading, closing and labeling
- smooth top and bottom surface for labeling



PACKAGING
Base and cover are packed separately in individual cartons



MATERIAL
– Base and cover in impact resistant ABS plastics



COLORS
– Cover in clear; base in gray or in various attractive standard colors

DIVIDERS

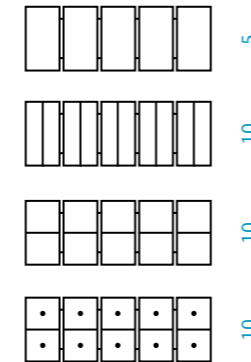

STANDARD COLORS



Product Range

Article	Number of units	Compartment design	Inner length unit	Inner width unit	Inner height	PU
ISBSL 18x37x8.5/1	5	without compartments	37mm	18mm	8.5mm	500
ISBSL 18x37x8.5/2	10	lengthwise dividers	37mm	8.5mm	8.5mm	500
ISBSL 18x37x8.5/3	10	widthwise dividers	18mm	18mm	8.5mm	500
ISBSL 18x37x8.5/4	10	widthwise divider+center pin	18mm	18mm	8.5mm	500
ISBSL 30x62x13/1	5	without compartments	62mm	30.5mm	13mm	190
ISBSL 30x62x13/2	10	widthwise dividers	30.5mm	30.5mm	13mm	190

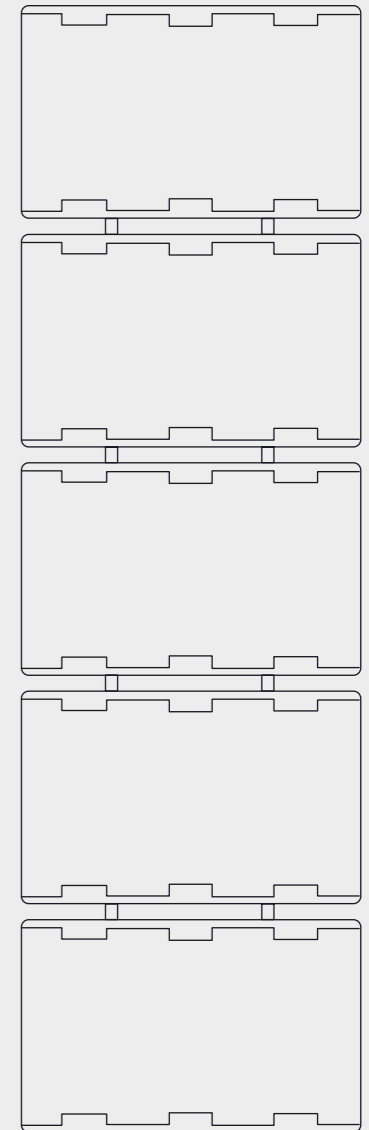

Super practical – 5 detachable individual boxes offer maximum safety for carbide inserts

MicroBox MB10

Packaging boxes with 10 holding devices for sensitive micro drills, precision drills, precision milling cutters and PCB drills

- simple and convenient handling thanks to ergonomic shaped closing system
- integrated clamping device holds tools safely in place
- both sides of pack close simultaneously, to trigger an integral clamping mechanism, which holds tools securely in place
- optional one-sided or two-sided length stop in the outer part



Small, smaller, micro (tools) – the integrated clamping device holds your smallest tools safely in place



PACKAGING
Carton



MATERIAL

- Box: K-Resin
- Insert 2.35mm: TPE
- Insert 3.175mm: PS



COLORS

- Box in clear, insert in various attractive standard colors

SHANK DIAM.

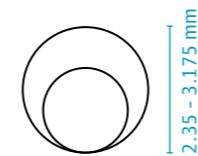

STANDARD COLORS



Product Range

Article	Version	Description	Number of holding devices	Shank diam.	Shank diam. (in.)	PU
MB 10/1 2.35 K	1	clamping device on one side	10	2.35mm		1000
MB 10/2 2.35 K	2	clamping device on both sides	10	2.35mm		1000
MB 10/1 3.175 K	1	clamping device on one side	10	3.175mm	1/8	1000
MB 10/2 3.175 K	2	clamping device on both sides	10	3.175mm	1/8	1000

MicroBox MB50

Packaging boxes with 50 holding devices for sensitive micro drills, precision drills, precision milling cutters and PCB drills

- two separate parts allowing a variety of color combinations
- with integrated insert for 50 tools, optional with clamping device or clamping device with springs for additional protection of sensitive tool tips
- empty box combined with foam insert offers universal application
- excellent for stacking and storage



PACKAGING
Parts are packed separately in individual cartons



MATERIAL
- Cover, base and clamping device: Polystyrene (PS)
- Clamping device with spring: Polypropylene (PP)



COLORS
- Cover in clear; base and clamping device in various attractive standard colors

STANDARD COLORS



Product Range

MicroBox MB50

Article	Version	Description	Shank diam.	Shank diam. (in.)	PU
MB 50/1 S	1	without compartments			200
MB 50/2 S	2	w/ 50 holding devices	3.175mm	1/8"	200

MicroBox MB50 Clamping Device

Article	Description	PU
MB 50 clamping device	clamping device w/o spring	535
MB 50 clamping device w.spring	clamping device w/ spring	692

Micro Vario Box

Packaging box with 10 holding devices for precision tools, micro drills, taps, milling cutters, diamond tools according to DIN 1897/338/339/334 etc.

- two parts, cover and base allowing for a variety of two-color combinations
- extremely strong
- excellent for stacking and storage
- durable and reusable



PACKAGING
Base and cover are packed separately in individual cartons



MATERIAL
- Polypropylene (PP)



COLORS
- Cover in transparent, base in various attractive standard colors

STANDARD COLORS



Product Range

Article	Number of holding devices	Shank diam.	Usable length fixed	PU
MVB 1.5	10	1.5mm	41mm	1000
MVB 1.0	10	1mm	41mm	1000
MVB 2.0	10	2mm	41mm	1000
MVB 3.0	10	3mm	41mm	1000
MVB 3.175	10	3.175mm	41mm	1000

DIY-Box



Plastic boxes with integrated hanger.
Ideal as packaging for profile cutters

DIY-Box

- DYP 24x24/1 I and DYP 40x40/1 I: base with "stepped" hole to accept 6 mm and 8 mm shank diameters
- maximum tool size 40 mm diameter x 70 mm height

DIY-FlapBox

- with flap mechanism and anti-theft closure
- maximum tool size 40 mm diameter x 70 mm height
- box with euro hanger



1

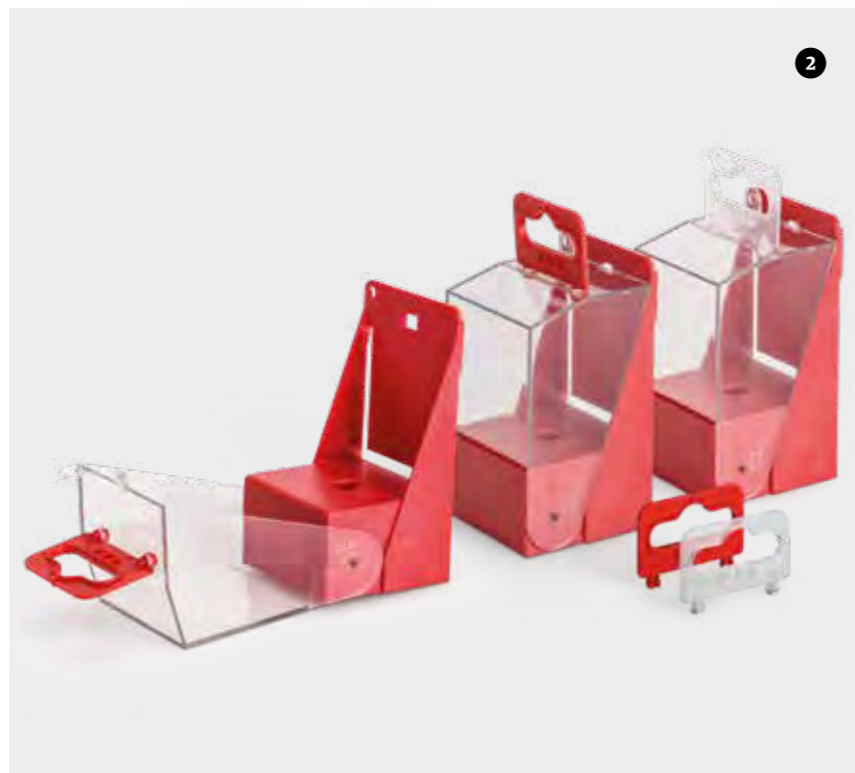

2



PACKAGING

- 1 Base plug and outer part are packed separately in individual cartons
- 2 Packed assembled



MATERIAL

- 1 **DIY-Box**
 - Base plug: Polypropylene (PP)
 - Outer part: Polyvinylchloride (PVC) / Polypropylene (PP)
- 2 **DIY-FlapBox**
 - box: polystyrene (PS)
 - cover: ABS plastic
 - hanger: polypropylene (PP)
 - safety pin: polyethylene (PE)



COLORS

- 1 **DIY-Box**
 - Base in various attractive standard colors
 - Outer part in clear (PVC) or transparent (PP)
- 2 **DIY-FlapBox**
 - Cover in clear, box, hanger and safety pin in various attractive standard colors on request

DIMENSIONS

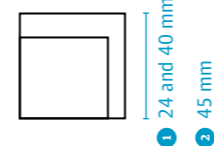

SHANK DIAM.



STANDARD COLORS



Product Range

1 DIY-Box base plug

Article	Part type	Inner length	Inner width	Shank diam.	Shank diam. (in.)	PU
DYP 24x24/1 I	base plug	24mm	24mm	6mm		700
DYP 40x40/1 I	base plug	40mm	40mm	6mm		480
DYP 40x40/3 I	base plug	40mm	40mm	10mm		480
DYP 40x40/2 I	base plug	40mm	40mm	12.7mm	1/2"	480

DIY-Box outer part

Article	Part type	Hanger	Inner length	Inner width	Inner height	PU
DYP-A 24x24 045/1 A	outer part	round hole hanger	24mm	24mm	45mm	700
DYP-A 24x24 057/1 A	outer part	round hole hanger	24mm	24mm	57mm	500
DYP-A 40x40 050/1 A	outer part	euro hole hanger	40mm	40mm	50mm	240
DYP-A 40x40 050/2 A	outer part	euro hole hanger	40mm	40mm	50mm	200
DYP 40x40 050/2 A	outer part	-	40mm	40mm	50mm	3500

2 DIY-FlapBox

Article	Inner length	Inner width	Inner height	Shank diam.	Shank diam. (in.)	PU
DYP 43x43/9	43mm	45mm	75mm	6mm	1/4	230
DYP 43x43/10	43mm	45mm	75mm	8mm	5/16	230



The ideal packaging for profile cutters – maximum protection with effective product presentation



SplitPack

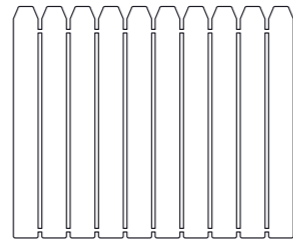

Multi-compartment packaging system with 10 individual detachable units for tap drills, burrs and shank tools

- versatile packaging combining single unit with multiple packaging
- SplitPack: 2-part version with separate base and lid (SP 4x40 and SP 4x60 are one-piece version)
- SplitPack with shankholding: with integrated shankholding feature in lid
- detachable units make this product very efficient and user-friendly
- no packing and repacking of single items necessary
- each unit is reusable with hinged lid and snap-closure
- speedy handling
- space saving
- excellent for stacking and storage



The only packaging we sell that's allowed to be broken. For safe transport and protection of multiple shank tools



PACKAGING

Outer parts and inner parts are packed separately in individual cartons



MATERIAL

- Polypropylene (PP)
- Recycled plastic



COLORS

- Depending on the material transparent, natural or in various attractive standard colors



ACCESSORIES

- Foam inserts (see page 182)

USABLE LENGTHS

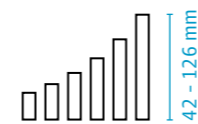

DIAMETER



STANDARD COLORS



Product Range

SplitPack

Article	Number of units	Inner diam. unit	Inner length	PU
SP 4x40/2	10	4mm	42mm	700
SP 6x40/2	10	6mm	42mm	520
SP 6x50/2	10	6mm	50mm	780
SP 6x66/2	10	6mm	66mm	625
SP 6x80/2	10	6mm	80mm	500
SP 6x100/2	10	6mm	103mm	405
SP 8x66/2	10	8mm	67mm	600
SP 8x80/2	10	8mm	82mm	500
SP 8x100/2	10	8mm	104mm	420
SP 8x125/2	10	8mm	126mm	340
SP 10x66/2	10	10mm	67mm	420
SP 10x80/2	10	10mm	82mm	360
SP 10x100/2	10	10mm	104mm	300
SP 10x125/2	10	10mm	126mm	250
SP 12x80/2	5	12mm	85mm	525
SP 12x95/2	5	12mm	95mm	360
SP 12x110/2	5	12mm	114mm	400
SP 16x80/2	5	16mm	84mm	330
SP 16x110/2	5	16mm	114mm	250

SplitPack with shankholding

Article	Number of units	Inner diam. unit	Shankholding diam	Inner length	PU
SP 6x50-2/2	10	6mm	2mm	50mm	780
SP 6x50-2.35/2	10	6mm	2.35mm	50mm	780
SP 6x50-2.8/2	10	6mm	2.35mm	50mm	780
SP 6x50-3/2	10	6mm	3mm	50mm	780
SP 6x66-2.35/2	10	6mm	2.35mm	66mm	625
SP 6x66-3/2	10	6mm	3mm	66mm	625
SP 8x66-3/2	10	8mm	3mm	67mm	600
SP 10x80-4/2	10	10mm	4mm	82mm	360
SP 10x80-6/2	10	10mm	6mm	82mm	360
SP 16x80-6/2	5	16mm	6mm	84mm	330



UniBox

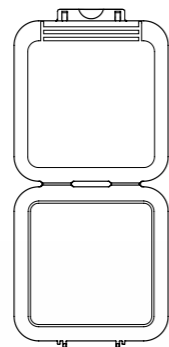

Plastic storage boxes with hinged lid and secure closure

- secure press closure and hinged lid
- speedy handling
- excellent for stacking and storage
- customized printing possible
- durable and reusable
- sturdy, oil, and moisture resistant



Multi-talent, all-rounder, universal genius. This box can be used for almost everything



PACKAGING
Carton



MATERIAL
- Polypropylene (PP)
- Recycled plastic



COLORS
- Depending on the material
transparent, natural or in various attractive standard colors



ACCESSORIES
- With hanger on request
- Foam inserts
(see page 180)

HEIGHTS



DIMENSIONS

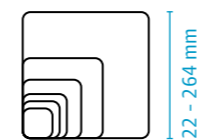

STANDARD COLORS



Product Range

UniBox square

Article	Version (Compartment design)	Inner length	Inner width	Inner height	PU
UB 22x8	1 and 2	22mm	22mm	8mm	1500
UB 35x4	1 and 3 (centering-Ø 1.8mm/0.07")	37mm	37mm	4mm	1000
UB 35x8	1 and 2	36mm	36mm	8mm	1000
UB 35x12	1 and 2	35mm	35mm	12mm	1000
UB 35x18	1	35mm	35mm	18mm	750
UB 35x25	1	35mm	35mm	25mm	600
UB 35x40	1	35mm	35mm	40mm	400
UB 47x6	1, 2, 3 (centering-Ø 4.85mm/0.19") and 8 (centering-Ø 5mm/0.2")	49mm	49mm	6mm	750
UB 47x19	1 and 2	47mm	47mm	19mm	730
UB 47x40	1	43mm	43mm	40mm	320
UB 58x6	1 and 3 (centering-Ø 10mm/0.39")	63mm	63mm	6mm	450
UB 58x12	1 and 3 (centering-Ø 10mm/0.39")	62mm	62mm	12mm	300
UB 58x25	1	60mm	60mm	25mm	400
UB 58x40	1	58mm	58mm	40mm	330
UB 67x6	1 and 3 (centering-Ø 10mm/0.39")	70mm	70mm	6mm	350
UB 67x12	1 and 3 (centering-Ø 10mm/0.39")	69mm	69mm	12mm	250
UB 67x26	1, 2 and 3 (centering-Ø 10mm/0.39")	67mm	67mm	26mm	300
UB 67x40	1	67mm	67mm	40mm	225
UB 85x6	1 and 3 (centering-Ø 16mm/0.63")	92mm	92mm	6mm	400
UB 85x12	1 and 3 (centering-Ø 16mm/0.63")	91mm	91mm	12mm	250
UB 85x25	1 and 3 (centering-Ø 16mm/0.63")	88mm	88mm	25mm	150
UB 85x40	1 and 3 (centering-Ø 16mm/0.63")	86mm	86mm	40mm	150
UB 100x6	1 and 3 (centering-Ø 16mm/0.63")	105mm	105mm	6mm	300
UB 100x12	1, 3 (centering-Ø 16mm/0.63") and 4 (centering-Ø 9.9mm/0.39")	103mm	103mm	12mm	200
UB 100x25	1 and 3 (centering-Ø 16mm/0.63")	101mm	101mm	25mm	250
UB 100x40	1, 3 (centering-Ø 16mm/0.63") and 4 (centering-Ø 20mm/0.79")	100mm	100mm	40mm	110
UB 125x6	1 and 3 (centering-Ø 16mm/0.63")	133mm	133mm	6mm	180
UB 125x12	1 and 3 (centering-Ø 16mm/0.63")	132mm	132mm	12mm	120
UB 125x25	1 and 3 (centering-Ø 16mm/0.63") and 4 (centering-Ø 22mm/0.87")	130mm	130mm	25mm	150
UB 125x40	1 and 3 (centering-Ø 16mm/0.63")	127mm	127mm	40mm	130
UB 160x6	1 and 3 (centering-Ø 16mm/0.63")	165mm	165mm	6mm	120
UB 160x12	1 and 3 (centering-Ø 16mm/0.63")	164mm	164mm	12mm	90
UB 160x25	1 and 3 (centering-Ø 16mm/0.63")	163mm	163mm	25mm	100
UB 160x40	1 and 3 (centering-Ø 16mm/0.63")	160mm	160mm	40mm	70
UB 200x6	1 and 3 (centering-Ø 16mm/0.63")	208mm	208mm	6mm	80
UB 200x12	1 and 3 (centering-Ø 16mm/0.63")	207mm	207mm	12mm	50
UB 200x25	1 and 3 (centering-Ø 16mm/0.63")	205mm	205mm	25mm	60
UB 200x40	1 and 3 (centering-Ø 16mm/0.63")	200mm	200mm	40mm	40
UB 250x6	1 and 3 (centering-Ø 16mm/0.63")	264mm	264mm	6mm	40
UB 250x12	1 and 3 (centering-Ø 16mm/0.63")	263mm	263mm	12mm	28
UB 250x25	1 and 3 (centering-Ø 16mm/0.63")	260mm	260mm	25mm	35

Version 1 = without centering; Version 2 = with conical centering;
Version 3, 4 and 8 = with cylindrical centering

Product Range



PACKAGING

Carton



MATERIAL

- Polypropylene (PP)
- Recycled plastic



COLORS

- PP transparent or in various attractive standard colors



ACCESSORIES

- With hanger on request

HEIGHTS

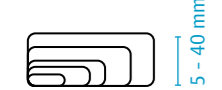

DIMENSIONS

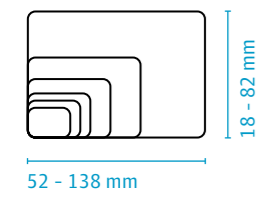

STANDARD COLORS

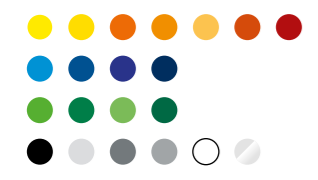

UniBox rectangular

Article	Compartment design	Description	Length	Width	Height	PU
UB 52x36x5/1	without compartments		52mm	36mm	5mm	1200
UB 18x55x7/1	without compartments		55mm	18mm	7mm	1000
UB 18x55x7/2	for set of 3 hand taps	M5, compartment size 6.5x55	55mm	18mm	7mm	1000
UB 18x55x7/3	with 10 compartments		55mm	18mm	7mm	1000
UB 18x55x25/1	without compartments		55mm	18mm	25mm	500
UB 18x69x7/1	without compartments		69mm	18mm	7mm	1000
UB 18x69x7/2	for set of 3 hand taps	M6, compartment size 6.5x69	69mm	18mm	7mm	1000
UB 18x69x25/1	without compartments		69mm	18mm	25mm	500
UB 69x45x26/1	without compartments		69mm	45mm	26mm	350
UB 69x45x41/1	without compartments		69mm	45mm	41mm	225
UB 31x82x11/1	without compartments		82mm	31mm	11mm	650
UB 31x82x11/2	for set of 3 hand taps	M10, compartment size 11x82	82mm	31mm	11mm	650
UB 31x82x40/1	without compartments		82mm	31mm	40mm	330
UB 53x107x18/1	without compartments		107mm	53mm	18mm	250
UB 53x107x18/2	for set of 3 hand taps	M16, compartment size 17x107	107mm	53mm	18mm	250
UB 53x107x40/1	without compartments		107mm	53mm	40mm	180
UB 59x126x22/1	without compartments		126mm	59mm	22mm	140
UB 59x126x22/2	for set of 3 hand taps	M20, compartment size 20x126	126mm	59mm	22mm	140
UB 59x126x40/1	without compartments		126mm	59mm	40mm	120
UB 82x138x27/1	without compartments		138mm	82mm	27mm	90
UB 82x138x27/2	for set of 3 hand taps	M24, compartment size 26x138	138mm	82mm	27mm	90
UB 82x138x40/1	without compartments		138mm	82mm	40mm	60

Inserts and rings for UniBox square

Article	Suitable for	Outer diam.	Outer diam. (in.)	Inner diam.	PU
Spring insert	UniBox 35x4/3				6000
UB-Ring 8/5	UniBox 47	8mm		5mm	6000
UB-Ring 10/5	UniBox 47	10mm		5mm	6000
UB-Ring 13/10	UniBox 67	13mm		10mm	6000
UB-Ring 16/10	UniBox 67	16mm		10mm	6000
UB-Ring 20/10	UniBox 67	20mm		10mm	6000
UB-Ring 22/10	UniBox 67	22mm		10mm	6000
UB-Ring 22/16	UniBox 85/100/125/160/200/250	22mm		16mm	6000
UB-Ring 25,4/16 (1)	UniBox 85/100/125/160/200/250	25.4mm	1	16mm	6000
UB-Ring 27/16	UniBox 85/100/125/160/200/250	27mm		16mm	6000
UB-Ring 31.75/16 (1.25)	UniBox 85/100/125/160/200/250	31.75mm	1 1/4	16mm	6000
UB-Ring 32/16	UniBox 85/100/125/160/200/250	32mm		16mm	3000
UB-Ring 38.1/16 (1.5)	UniBox 85/100/125/160/200/250	38.1mm	1 1/2	16mm	4000
UB-Ring 40/16	UniBox 85/100/125/160/200/250	40mm		16mm	3000
UB-Ring 50/16 (2)	UniBox 85/100/125/160/200/250	50mm	2	16mm	1500



UniBox...

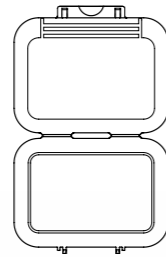

Plastic storage boxes with hinged lid and secure closure

...for Micro Tools ①

- shankholding through integral clips
- secure press closure and hinged lid
- excellent for stacking and storage

...for Spade Drill Inserts ②

- optimum fit through center post
- secure press closure and hinged lid
- durable and reusable
- excellent for stacking and storage
- sturdy, oil, and moisture resistant



PACKAGING
Carton



MATERIAL
- Polypropylene (PP)



COLORS
- PP transparent or in various attractive standard colors

HEIGHTS



DIMENSIONS

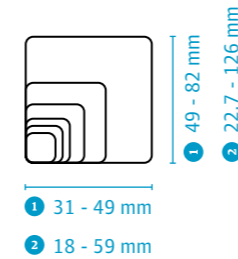

SHANK DIAM.

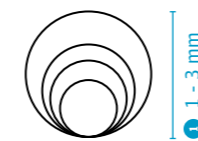

STANDARD COLORS



Product Range

① UniBox for Micro Tools

Article	Inner length	Inner width	Inner height	Number of holding devices	Shank diam.	PU
UB 47x6/4	49mm	49mm	6mm	10	1mm	750
UB 47x6/5	49mm	49mm	6mm	10	1.5mm	750
UB 47x6/6	49mm	49mm	6mm	10	2mm	750
UB 47x6/9	49mm	49mm	6mm	10	3mm	750
UB 47x6/10	49mm	49mm	6mm	10	1.9mm	750
UB 47x8/7	49mm	49mm	8mm	6	2.35mm	600
UB 52x36x5/2	52mm	36mm	5mm	10	2.3mm	1200
UB 31x82x7/2	82mm	31mm	7mm	10	2.8mm	850

② UniBox for Spade Drill Inserts

Article	Suitable for	Number of holding devices	Inner length	Inner width	Inner height	PU
UB 22x8/4	series Y/Z	2	22.7mm	22.7mm	8mm	1000
UB 35x8/5	series 0	2	35.5mm	35.5mm	8mm	1000
UB 35x8/4	series 1	1	35.5mm	35.5mm	8mm	1000
UB 35x8/3	series 2	1	35.5mm	35.5mm	8mm	1000
UB 18x55x7/4	series 3	1	55mm	18mm	7mm	1000
UB 31x82x11/4	series 4	1	82mm	31mm	11mm	650
UB 31x82x11/3	series 5	1	82mm	31mm	11mm	650
UB 53x107x18/3	series 6/7	1	107mm	53mm	18mm	250
UB 59x126x22/3	series 8	1	126mm	59mm	22mm	140

Standardization

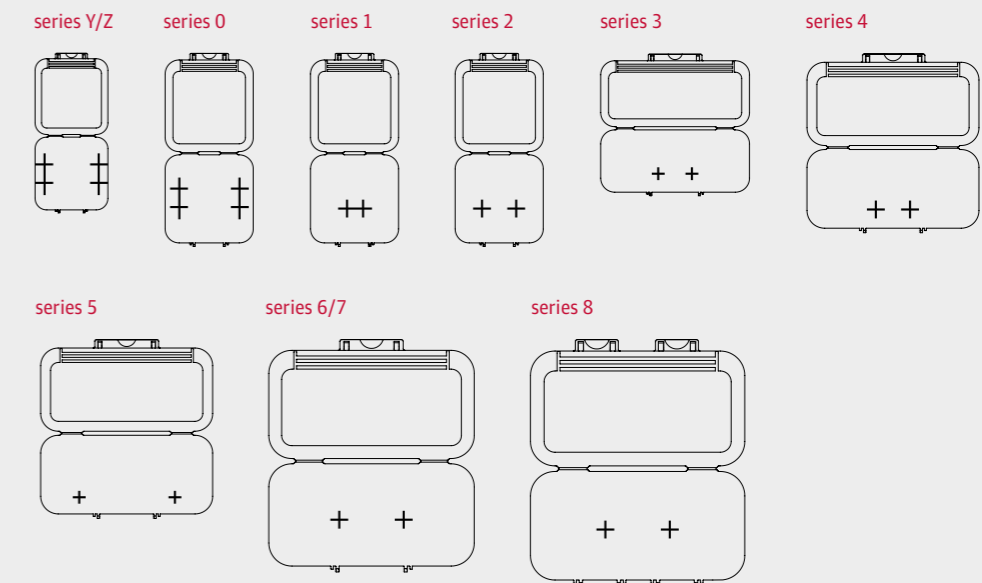

One box, so many possibilities. From micro tools to spade drill inserts – they are all safely packed via the integral clip or center mount

Plastic cases

Keep your products organized and protected while on the move

Our plastic cases are the ideal protective, sales, and transport packaging solution for a wide variety of products. We offer a smart selection of high-quality plastic cases for various industries and applications.



Rose Case ErgoLine

Plastic cases with top functionality and sales boosting design
more on page 124

organized and protected



Rose Case ProTec

Plastic cases in exclusive design for perfect protection of your products
more on page 130

MK-Case

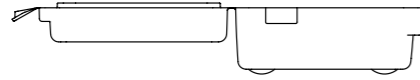

Plastic cases sturdily designed for all-around protection of high-quality milling cutter heads

- secure center fixing screw offers high protection of cutting edge
- extremely strong blown double-wall case
- centering points on base and cover for secure stacking
- built in recess points for easy tool removal
- textured ergonomic carry handle
- durable hinges
- sturdy hinge and lock system
- recessed area on lid for labeling
- available to accommodate various tool diameters
- customized branding available on lid and fixing screw
- built in storage compartment for accessories
- additional adapter rings available to accommodate other arbor holes



All-round carefree package – the protection your high-quality milling cutter heads deserve



PACKAGING

Packed assembled



MATERIAL

- Case shells in Polyethylene (PE)
- Closures, fixing screws and adapter rings in ABS



COLORS

- MKC 50, 80, 160 and 250 case shells in black; MKC 160 and 250 closures in red
- Further colors and color combinations on request



ACCESSORIES

- Adapter

TOOL DIAM.

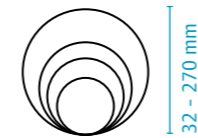

STANDARD COLORS



Product Range

MK-Case

Article	Description	w x h x d	Max. tool diameter Ø 45/90°	Tool holder diam.	max. tool length	PU
F-MK Case 50 01/01	w/ foam insert in cover	109x99x76mm	32, 40, 50, 63	15.88mm	50mm	1000
F-MK Case 80 01/01	w/ foam insert in cover	141x131x74mm	80/100	15.88mm	50mm	30
F-MK Case 160 01/02	adapter Ø 38 and fixing screw	272x217x130mm	160/180	32/38mm	63mm	8
F-MK Case 160 02/02	adapter Ø 40 and fixing screw	272x217x130mm	160/180	32/40mm	63mm	8
F-MK Case 250 01/02	adapter Ø 60 and fixing screw	380x320x130mm	250/270	40/60mm	63mm	6

Accessories for MK-Case 50 and 80

Article	Suitable for	Shank diam.	Shank diam. (in.)	PU
MKC 80 Adapter 19	MK-Case 50/80	19mm	3/4	120
MKC 80 Adapter 22	MK-Case 50/80	22mm		4800
MKC 80 Adapter 25	MK-Case 80	25mm	1	120
MKC 80 Adapter 27	MK-Case 80	27mm		120

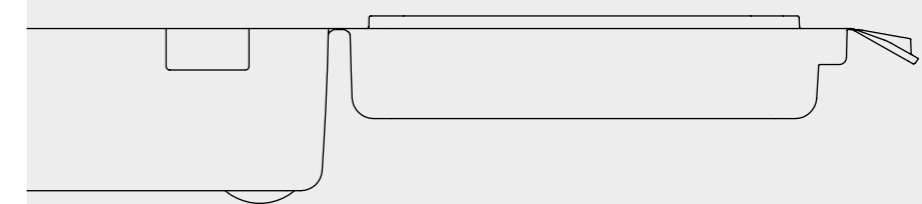

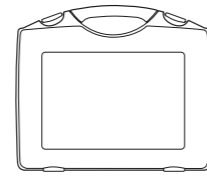

RoseCase ErgoLine

Plastic cases with top functionality and sales boosting design

- modern design gives striking impact
- extremely adaptable to specific market or product requirements through numerous color combinations and various options of interior design – including plain, convoluted, or die-cut foam inserts
- lids and bases can be custom printed or embossed with company logo
- with polished and textured surface label area
- optional transparent lid provides perfect product visibility
- ergonomic handle, optional with 'soft-touch'
- concealed hinges, sturdy integrated feet
- numerous secondary uses
- excellent for stacking and storage



Modern design combined with top functionality – a packaging solution in a class of its own



PACKAGING

Packed assembled



MATERIAL

- Polypropylene (PP)
- Recycled plastic
- Standard version with polished label area



COLORS

- Standard colors "M" & "L": black, red, blue, silver-gray and transparent
- Standard colors "S": transparent
- Closures in black, blue, red, silver-gray or in transparent
- Additional colors and color combinations upon request



ACCESSORIES

- Please inquire for customized foam inserts

INSIDE DEPTHS

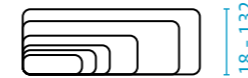

INNER DIMENSIONS

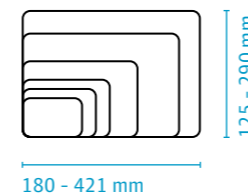

STANDARD COLORS



Product Range

RoseCase ErgoLine

Article	Outer width	- height	- depth	Inner width	- height	- depth	PU
RCEL 125 S	197mm	167mm	23mm	180mm	125mm	18mm	45
RCEL 125 SM	197mm	167mm	35mm	180mm	125mm	30mm	30
RCEL 125 M	197mm	167mm	47mm	180mm	125mm	42mm	22
RCEL 155 S	244mm	207mm	29mm	225mm	155mm	23mm	30
RCEL 155 SM	244mm	207mm	44mm	225mm	155mm	38mm	20
RCEL 155 M	244mm	207mm	59mm	225mm	155mm	53mm	15
RCEL 175 S	275mm	231mm	31mm	255mm	175mm	26mm	30
RCEL 175 SM	275mm	231mm	48mm	255mm	175mm	43mm	20
RCEL 175 M	275mm	231mm	65mm	255mm	175mm	60mm	15
RCEL 195 S	307mm	260mm	35mm	284mm	195mm	30mm	40
RCEL 195 SM	307mm	260mm	55mm	284mm	195mm	48mm	25
RCEL 195 M	307mm	260mm	74mm	284mm	195mm	66mm	18
RCEL 220 S	346mm	292mm	39mm	320mm	220mm	34mm	28
RCEL 220 SM	346mm	292mm	62mm	320mm	220mm	56mm	18
RCEL 220 M	346mm	292mm	84mm	320mm	220mm	78mm	13
RCEL 250 M	393mm	331mm	95mm	365mm	250mm	90mm	8
RCEL 290 M	456mm	384mm	110mm	421mm	290mm	100mm	5
RCEL 290 ML	456mm	384mm	127mm	421mm	290mm	116mm	4
RCEL 290 L	456mm	384mm	144mm	421mm	290mm	132mm	4

first letter stands for cover, second letter stands for base; e.g. SM = cover size S and base size M

Foam inserts for RoseCase ErgoLine

Article	Suitable for	Height	PU	Article	Suitable for	Height	PU
SE Burl RCEL 125/10	RCEL 125	10mm	1	SE flat foam RCEL 125/10	RCEL 125	10mm	1
SE Burl RCEL 125/15	RCEL 125	15mm	1	SE flat foam RCEL 125/15	RCEL 125	15mm	1
SE Burl RCEL 125/20	RCEL 125	20mm	1	SE flat foam RCEL 125/20	RCEL 125	20mm	1
SE Burl RCEL 155/10	RCEL 155	10mm	1	SE flat foam RCEL 155/10	RCEL 155	10mm	1
SE Burl RCEL 155/15	RCEL 155	15mm	1	SE flat foam RCEL 155/15	RCEL 155	15mm	1
SE Burl RCEL 155/20	RCEL 155	20mm	1	SE flat foam RCEL 155/20	RCEL 155	20mm	1
SE Burl RCEL 155/25	RCEL 155	25mm	1	SE flat foam RCEL 155/25	RCEL 155	25mm	1
SE Burl RCEL 175/10	RCEL 175	10mm	1	SE flat foam RCEL 175/10	RCEL 175	10mm	1
SE Burl RCEL 175/15	RCEL 175	15mm	1	SE flat foam RCEL 175/15	RCEL 175	15mm	1
SE Burl RCEL 175/25	RCEL 175	25mm	1	SE flat foam RCEL 175/30	RCEL 175	30mm	1
SE Burl RCEL 175/30	RCEL 175	30mm	1	SE flat foam RCEL 195/15	RCEL 195	15mm	1
SE Burl RCEL 195/15	RCEL 195	15mm	1	SE flat foam RCEL 195/20	RCEL 195	20mm	1
SE Burl RCEL 195/30	RCEL 195	30mm	1	SE flat foam RCEL 195/30	RCEL 195	30mm	1
SE Burl RCEL 195/35	RCEL 195	35mm	1	SE flat foam RCEL 195/35	RCEL 195	35mm	1
SE Burl RCEL 220/15	RCEL 220	15mm	1	SE flat foam RCEL 195/35	RCEL 195	35mm	1
SE Burl RCEL 220/20	RCEL 220	20mm	1	SE flat foam RCEL 220/15	RCEL 220	15mm	1
SE Burl RCEL 220/30	RCEL 220	30mm	1	SE flat foam RCEL 220/25	RCEL 220	25mm	1
SE Burl RCEL 220/35	RCEL 220	35mm	1	SE flat foam RCEL 220/35	RCEL 220	35mm	1
SE Burl RCEL 220/40	RCEL 220	40mm	1	SE flat foam RCEL 220/40	RCEL 220	40mm	1
SE Burl RCEL 250/40	RCEL 250	40mm	1	SE flat foam RCEL 250/25	RCEL 250	25mm	1
SE Burl RCEL 250/50	RCEL 250	50mm	1	SE flat foam RCEL 250/45	RCEL 250	45mm	1
SE Burl RCEL 290/40	RCEL 290	40mm	1	SE flat foam RCEL 290/50	RCEL 290	50mm	1
SE Burl RCEL 290/50	RCEL 290	50mm	1	SE flat foam RCEL 290/65	RCEL 290	65mm	1
SE Burl RCEL 290/60	RCEL 290	60mm	1	SE flat foam RCEL 290/25	RCEL 290 L	25mm	1
				SE flat foam RCEL 290/25	RCEL 290 M	25mm	1

TOUGH.
DUSTPROOF.
WATERPROOF.
RELIABLE.

Rose Case ProSecure

Strong cases and boxes for indoor and outdoor use – extremely durable and sturdy. Ideal for protecting high-quality items

- robust due to the extra thick wall
- waterproof sealing ring in the case lid provides reliable protection against dust and water
- P67 certified (except RCPS 350 TR, 350 TR-R, 350 TR-P, 350 TR-W)
- automatic pressure release valve ensures pressure regulation
- easy to open with double throw latches
- eyelets for padlocking
- sturdy hinges over the complete length
- nylon pins for corrosion protection
- comfortable grip handle
- holes for shoulder strap (RCPS 290/1, 350, 350 TR)
- wide range of models with wheels and extendable telescopic handle
- excellent for stacking and storage
- labelling area available
- lid can be custom-printed



PACKAGING
Packed assembled



MATERIAL

- Body and handle: Polypropylene (PP)
- Latches: Nylon
- Sealing ring: Polymer



COLORS

- Black, transparent, orange, green



ACCESSORIES

- Wheels, extendable handle, shoulder strap and lid organizer

INSIDE DEPTHS

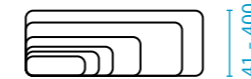

INNER DIMENSIONS

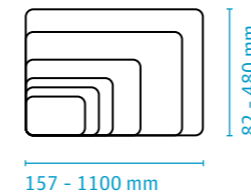

STANDARD COLORS



Product Range

Article	Description	With wheels	With extendable handle	Foam in bottom	Foam in cover	Inside dimensions WxHxD	PU
RCPS 82						157x82x41	12
RCPS 82/2	4 compartments lengthwise					157x82x41	12
F-RCPS 82-R				cubed foam	convoluted foam	157x82x41	12
F-RCPS 82-N				convoluted foam	convoluted foam	157x82x41	12
RCPS 140						212x140x47	12
RCPS 140/2	3-15 compartments					212x140x47	12
F-RCPS 140-R				cubed foam	convoluted foam	212x140x47	12
F-RCPS 140-N				convoluted foam	convoluted foam	212x140x47	12
RCPS 180						235x180x106	4
F-RCPS 180-R				cubed foam	convoluted foam	235x180x106	4
RCPS 180 L						235x180x156	4
F-RCPS 180 L-R				cubed foam	convoluted foam	235x180x156	4
RCPS 195						316x195x53	6
RCPS 195/2	3-15 compartments					316x195x53	6
F-RCPS 195-R				cubed foam	convoluted foam	316x195x53	6
F-RCPS 195-N				convoluted foam	convoluted foam	316x195x53	6
RCPS 195 L						316x195x81	4
RCPS 195/2 L	3 compartments widthwise					316x195x81	4
F-RCPS 195 L-R				cubed foam	convoluted foam	316x195x81	4
RCPS 225						300x225x132	4
F-RCPS 225-R				cubed foam	convoluted foam	300x225x132	4
RCPS 230						400x230x260	2
F-RCPS 230-R				cubed foam	convoluted foam	400x230x260	2
RCPS 270/1						380 x 270 x 115	2
F-RCPS 270/1-R				cubed foam	convoluted foam	380 x 270 x 115	2
RCPS 270/2						380 x 270 x 160	2
F-RCPS 270/2-R				cubed foam	convoluted foam	380 x 270 x 160	2
RCPS 290/1						426x290x159	2
F-RCPS 290/1-R				cubed foam	convoluted foam	426x290x159	2
RCPS 290/1-P	w/ divider insert					426x290x159	2
RCPS 290/1-W	w/ tool insert/lid organizer					426x290x159	2
RCPS 335/1						465x335x125	1
F-RCPS 335/1-R				cubed foam	convoluted foam	465x335x125	1
RCPS 335/2						465x335x220	1
F-RCPS 335/2-R				cubed foam	convoluted foam	465x335x220	1
RCPS 335/2 TR		x	x			465x335x220	1
F-RCPS 335/2 TR-R		x	x	cubed foam	convoluted foam	465x335x220	1
RCPS 350						500x350x194	1
F-RCPS 350-R				cubed foam	convoluted foam	500x350x194	1
RCPS 350-P	iw/ divider insert					500x350x194	1
RCPS 350-W	w/ tool insert/lid organizer					500x350x194	1
RCPS 350 TR		x	x			500x350x194	1
F-RCPS 350 TR-R		x	x	cubed foam	convoluted foam	500x350x194	1
RCPS 350 TR-P	w/ divider insert	x	x			500x350x194	1
RCPS 350 TR-W	w/ tool insert/lid organizer	x	x			500x350x194	1

 **Need to store delicate objects safely? You've come to the right place. High security for high-quality items**

Product Range



PACKAGING
Packed assembled



MATERIAL

- Body and handle: Polypropylene (PP)
- Latches: Nylon
- Sealing ring: Polymer



COLORS

- Black, transparent, orange, green



ACCESSORIES

- Wheels, extendable handle, shoulder strap and lid organizer

INSIDE DEPTHS

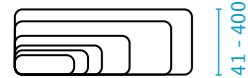

INNER DIMENSIONS

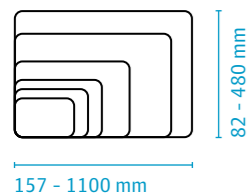

STANDARD COLORS



Article	Description	With wheels	With extendable handle	Foam in bottom	Foam in cover	Inside dimensions WxHxD	PU
RCPS 350 L						500x350x280	1
F-RCPS 350 L-R				cubed foam	convoluted foam	500x350x280	1
RCPS 350 L TR		x	x			500x350x280	1
F-RCPS 350 L TR-R		x	x	cubed foam	convoluted foam	500x350x280	1
RCPS 290/2						520x290x200	1
F-RCPS 290/2-R				cubed foam	convoluted foam	520x290x200	1
RCPS 290/2 TR		x	x			520x290x200	1
F-RCPS 290/2 TR-R		x	x	cubed foam	convoluted foam	520x290x200	1
RCPS 405						538x405x190	1
F-RCPS 405-R				cubed foam	convoluted foam	538x405x190	1
RCPS 405 TR		x	x			538x405x190	1
F-RCPS 405 TR-R		x	x	cubed foam	convoluted foam	538x405x190	1
RCPS 405 L						538x405x245	1
F-RCPS 405 L-R				cubed foam	convoluted foam	538x405x245	1
RCPS 405 L-TR		x	x			538x405x245	1
F-RCPS 405 L TR-R		x	x	cubed foam	convoluted foam	538x405x245	1
RCPS 615						615x615x360	1
F-RCPS 615-R				cubed foam	convoluted foam	615x615x360	1
RCPS 615 TR		x	x			615x615x360	1
F-RCPS 615 TR-R		x	x	cubed foam	convoluted foam	615x615x360	1
RCPS 460		x				620x460x250	1
F-RCPS 460-R		x		cubed foam	convoluted foam	620x460x250	1
RCPS 460 TR		x	x			620x460x250	1
F-RCPS 460 TR-R		x	x	cubed foam	convoluted foam	620x460x250	1
RCPS 460 L		x				620x460x340	1
F-RCPS 460 L-R		x		cubed foam	convoluted foam	620x460x340	1
RCPS 460 L-TR		x	x			620x460x340	1
F-RCPS 460 L TR-R		x	x	cubed foam	convoluted foam	620x460x340	1
RCPS 480		x				750x480x280	1
F-RCPS 480-R		x		cubed foam	convoluted foam	750x480x280	1
RCPS 480 L		x				750x480x400	1
F-RCPS 480 L-R		x		cubed foam	convoluted foam	750x480x400	1
RCPS 370						800x370x140	1
F-RCPS 370-R				cubed foam	convoluted foam	800x370x140	1
F-RCPS 370-N		x		convoluted foam	convoluted foam	800x370x140	1
RCPS 600		x				820x600x450	1
F-RCPS 600-R		x		cubed foam	convoluted foam	820x600x450	1
RCPS 370 L		x				1100x370x140	1
F-RCPS 370 L-R		x		cubed foam	convoluted foam	1100x370x140	1
F-RCPS 370 L-N		x		convoluted foam	convoluted foam	1100x370x140	1

Accessories

Article	Description	Suitable for	Outer width	Outer height	Outer depth	PU
RCPS 1000	wheels & extendable handle	RCPS 290/2	530mm	170mm	20mm	1
RCPS 1001	wheels & extendable handle	RCPS 405, 405L	530mm	170mm	20mm	1
RCPS 1002	extendable handle	RCPS 460, 460L	580mm	170mm	20mm	1
RCPS 1003	wheel set	RCPS 290/2, 405, 405L				1
RCPS 1004	shoulder strap	RCPS 290/1, 350, 350 TR	1500mm	30mm	1mm	1
RCPS 1005	lid organizer	RCPS 290/1	410mm	270mm	60mm	1
RCPS 1006	lid organizer	RCPS 350, 350 TR	475mm	330mm	60mm	1



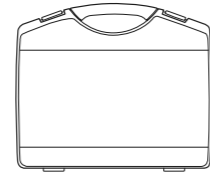

RoseCase ProTec

Exclusive plastic case designed to perfectly protect your product



- top quality and technically designed case prevents case shells from bending or twisting
- optional transparent lid provides perfect product visibility
- with polished and textured surface label area
- strong and durable 180° opening closures
- concealed hinges and sturdy, cleverly integrated feet
- extremely adaptable to specific market or product requirements through numerous color combinations and various options of interior design – including plain, convoluted, or die-cut foam inserts
- lids and bases can be custom printed or embossed with company logo
- sturdy and reusable; excellent for stacking and storage



All in one (case) – maximum protection with an appealing product presentation



PACKAGING
Packed assembled



MATERIAL

- Polypropylene (PP)
- Recycled plastic
- Standard version with polished label area



COLORS

- Standard colors: cover/base in black and transparent; closures in black and red
- RCPT 105: cover with integrated closures; color of closures corresponds to the color of the cover
- Additional colors and color combinations upon request



ACCESSORIES

- Please inquire for customized foam inserts

INNER DEPTHS

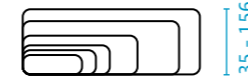

INNER DIMENSIONS

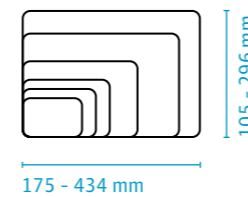

STANDARD COLORS



Product Range

RoseCase ProTec

Article	Outer width	- height	- depth	Inner width	- height	- depth	PU
RCPT 105 M	187mm	143mm	42mm	175mm	105mm	35mm	28
RCPT 136 M	240mm	183mm	48mm	228mm	136mm	42mm	24
RCPT 161 L	262mm	210mm	72mm	244mm	161mm	66mm	10
RCPT 175 M	275mm	225mm	84mm	261mm	175mm	77mm	9
RCPT 222 S	338mm	273mm	84mm	326mm	222mm	77mm	12
RCPT 222 SM	338mm	273mm	123mm	326mm	222mm	116mm	8
RCPT 222 M	338mm	273mm	163mm	326mm	222mm	156mm	6
RCPT 237 M	395mm	295mm	107mm	382mm	237mm	100mm	5
RCPT 296 M	456mm	357mm	140mm	434mm	296mm	132mm	4

Foam inserts for RoseCase ProTec

Article	Shape	Suitable for	Outer height	PU
SE Burl RCPT 105/10	convoluted foam	RCPT 105	10mm	1
SE Burl RCPT 105/15	convoluted foam	RCPT 105	15mm	1
SE Burl RCPT 105/20	convoluted foam	RCPT 105	20mm	1
SE Burl RCPT 136/20	convoluted foam	RCPT 136	20mm	1
SE Burl RCPT 161/30	convoluted foam	RCPT 161	30mm	1
SE Burl RCPT 175/35	convoluted foam	RCPT 175	35mm	1
SE Burl RCPT 175/40	convoluted foam	RCPT 175	40mm	1
SE Burl RCPT 222/25	convoluted foam	RCPT 222	25mm	1
SE Burl RCPT 222/35	convoluted foam	RCPT 222	35mm	1
SE Burl RCPT 222/40	convoluted foam	RCPT 222	40mm	1
SE Burl RCPT 222/50	convoluted foam	RCPT 222	50mm	1
SE Burl RCPT 222/60	convoluted foam	RCPT 222	50mm	1
SE Burl RCPT 237/50	convoluted foam	RCPT 237	50mm	1
SE Burl RCPT 296/25	convoluted foam	RCPT 296	25mm	1
SE Burl RCPT 296/40	convoluted foam	RCPT 296	40mm	1
SE Burl RCPT 296/60	convoluted foam	RCPT 296	60mm	1
SE Flat foam RCPT 105/10	flat foam	RCPT 105	10mm	1
SE Flat foam RCPT 105/20	flat foam	RCPT 105	20mm	1
SE Flat foam RCPT 136/15	flat foam	RCPT 136	15mm	1
SE Flat foam RCPT 136/20	flat foam	RCPT 136	20mm	1
SE Flat foam RCPT 161/15	flat foam	RCPT 161	15mm	1
SE Flat foam RCPT 161/30	flat foam	RCPT 161	30mm	1
SE Flat foam RCPT 175/25	flat foam	RCPT 175	25mm	1
SE Flat foam RCPT 175/35	flat foam	RCPT 175	35mm	1
SE Flat foam RCPT 222/20	flat foam	RCPT 222	20mm	1
SE Flat foam RCPT 222/35	flat foam	RCPT 222	35mm	1
SE Flat foam RCPT 222/50	flat foam	RCPT 222	50mm	1
SE Flat foam RCPT 222/75	flat foam	RCPT 222	75mm	1
SE Flat foam RCPT 237/35	flat foam	RCPT 237	35mm	1
SE Flat foam RCPT 237/50	flat foam	RCPT 237	50mm	1
SE Flat foam RCPT 296/25	flat foam	RCPT 296	25mm	1
SE Flat foam RCPT 296/40	flat foam	RCPT 296	40mm	1
SE Flat foam RCPT 296/60	flat foam	RCPT 296	60mm	1



RoseCase RCB and RCS

Two universally useful cases – the extra-sturdy RoseCase RCB in XXL format and the lightweight RoseCase RCS with space-saving folding handle

RoseCase RCB 1

- the XXL case version with more space
- extremely strong blown double-wall case
- sturdy hinge and lock system



RoseCase RCS 2

- universal applications
- with functional snap-down handle
- light but strong



PACKAGING
Packed assembled



MATERIAL
1 RoseCase RCB
 – Polyethylene (PE)
2 RoseCase RCS
 – Polypropylene (PP)
 – Recycled plastic



COLORS
1 RoseCase RCB
 – Available in various attractive standard colors – please inquire
2 RoseCase RCS
 – Standard colors in black, red, blue and transparent

INNER DEPTHS

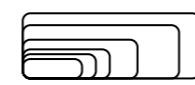

1 180 - 204 mm
2 32 and 35 mm

INNER DIMENSIONS

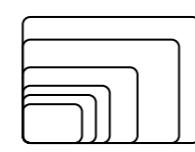

1 340 - 490 mm
2 105 and 148 mm

STANDARD COLORS



Product Range

1 RoseCase RCB

Article	Outer width	- height	- depth	Inner width	- height	- depth	PU
RCB 01	400mm	325mm	200mm	340mm	215mm	180mm	1
RCB 02	480mm	390mm	200mm	410mm	270mm	180mm	1
RCB 03	560mm	450mm	220mm	490mm	330mm	200mm	1
RCB 04	490mm	400mm	235mm	410mm	280mm	204mm	1

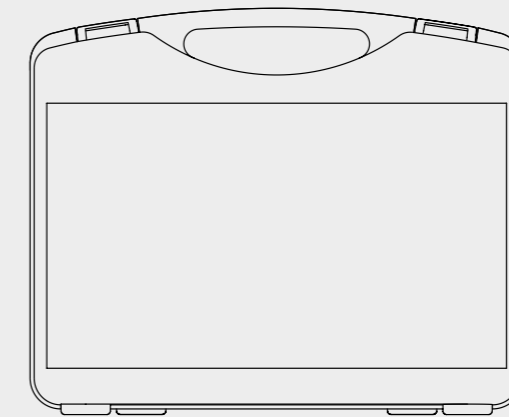

2 RoseCase RCS

Article	Outer width	- height	- depth	Inner width	- height	- depth	PU
RCS 1136 K	155mm	133mm	36mm	148mm	105mm	32mm	134
RCS 1240 K	113mm	249mm	40mm	105mm	220mm	35mm	84

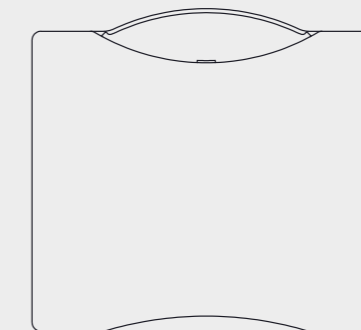

RoseCassette

Ergonomically optimized plastic assortment box with removable inserts. Ideal for drills, screws and small parts

- high transparency lid offers optimum visibility to contents
- user-friendly, easy grasp features on both sides
- 90° swiveling, retractable handle; additional safety lock prevents accidental opening
- extremely adaptable to specific market or product requirements due to a variety of color combinations and various interior design options – including convoluted or plain foam and die-cut foam inserts
- excellent scope for printing and labeling, product information can be printed in full view on the cassette lid
- universal application
- excellent for stacking and storage
- numerous secondary uses



PACKAGING
Packed assembled



- MATERIAL**
- Cassette: Polystyrene (PS) / ABS
 - Closures: Polypropylene (PP)
 - Handle: Polyethylene (PE)
 - Thermoformed insert: Polystyrene (PS)



- COLORS**
- Base in black, cover in clear, closures and handle in red
 - Colors and color combinations on request



- ACCESSORIES**
- StorePack (see page 164)

INNER DEPTH

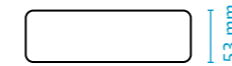

INNER DIMENSION

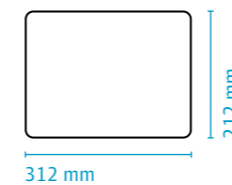

STANDARD COLORS



Product Range

RoseCassette

Article	Outer width	- height	- depth	Inner width	- height	- depth	PU
CR 212/02 K 006	326mm	241mm	57mm	312mm	212mm	53mm	11

Thermoformed inserts for RoseCassette

Article	Description	Suitable for	Number of compartments	Compartment size	PU
INS CR 212/1 BAS	thermoformed base	170 pcs. HSS/ Ø 1-10x0.5mm	0		50
INS CR 212/1 COV	thermoformed cover	170 pcs. HSS drills	0		300
INS CR 212/2 BAS	thermoformed insert	universal applications	4	136X86X49	28
INS CR 212/3 BAS	thermoformed insert	universal applications	8	61X86X49	28
INS CR 212/4 BAS	thermoformed insert	universal applications	12	61X53X49	28
INS CR 212/5 BAS	thermoformed insert	universal applications	16	61X38X49	28
INS CR 212/6 BAS	thermoformed insert	universal applications	18	53X38X49	28
INS CR 212/7 BAS	thermoformed insert	universal applications	24	38X38X49	28

 This assortment box with a highly transparent lid is ideal for drills, screws, and small parts – so you can always see what's what (and where)

UniCase

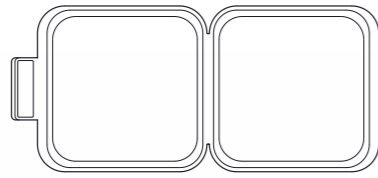

**Plastic cases in sturdy double-wall design.
Ideal for high quality tools and special parts**

- interior design options include convoluted or plain foam, or die-cut foam inserts, according to customer specification
- double-wall design offers optimum protection for the content
- version plain – without compartments possible
- version with center post possible



PACKAGING
Packed assembled



MATERIAL
- Polyethylene (PE)



COLORS
- In black or in various attractive standard colors



ACCESSORIES
- Foam inserts (see page 180)

INNER DEPTHS

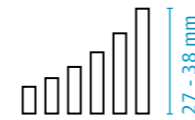

INNER DIMENSIONS

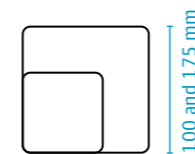

STANDARD COLORS



Product Range

Article	Description	Inner width	Inner height	Inner depth	PU
UC 100x27/3	w/ center spigot Ø 22+recess	100mm	100mm	27mm	64
UC 100x32/1	w/o compartment	100mm	100mm	32mm	51
UC 100x32/2	w/ center spigot Ø 22	100mm	100mm	32mm	51
UC 100x32/4	w/ center spigot Ø 25.4	100mm	100mm	32mm	51
UC 175x35/3	w/ center spigot Ø 22+recess	175mm	175mm	35mm	36
UC 175x38/1	w/o compartment	175mm	175mm	38mm	36
UC 175x38/2	w/ center spigot Ø 22	175mm	175mm	38mm	36
UC 175x38/4	w/ center spigot Ø 29.5	175mm	175mm	38mm	36
UC 175x38/5	w/ center spigot Ø 49.5	175mm	175mm	38mm	36

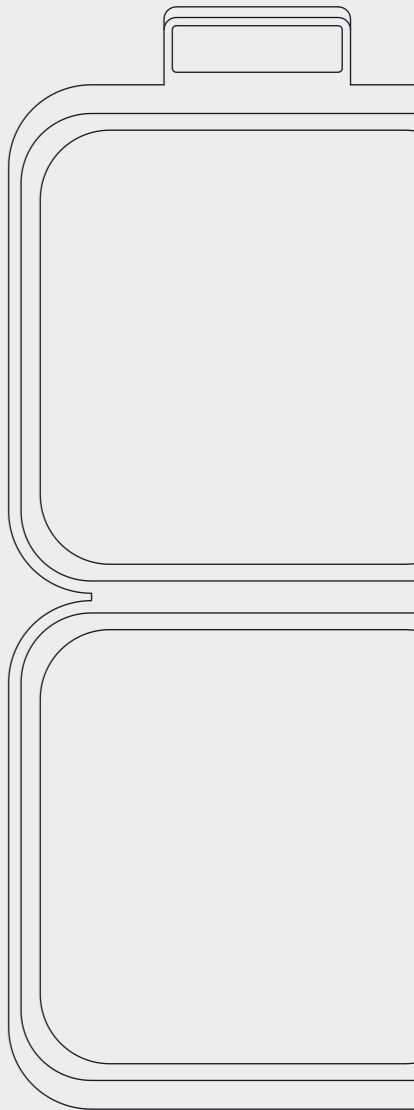

Safety first – this double-walled plastic case perfectly protects high-quality tools and special parts

Plastic cassettes

Stylish, safe, and sturdy cassettes.

rose plastic is your first port of call for secure and cost-effective packaging for drill sets. We carry an extensive standard range of plastic cassettes that are compatible with a large number of popular drill sets.



GripBox

...has a firm grip on your tools!
Plastic drill cassettes for drill bit sets
more on page 150



FACassette

Plastic drill cassettes for all types of drill bit sets
more on page 140

RoseBox

High-quality plastic cassettes in modern design. Ideal for all kinds of drill bit sets, precision tools, shank tools, special tool sets and spare parts
more on page 152

FA Cassette

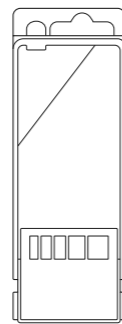

Plastic drill cassettes for all types of drill bit sets (HSS / Masonry / SDS / Wood drills etc.)

- four individual parts: cover, base, insert and safety pin
- clear hinged cover
- secure anti-theft closure with safety pin
- printing available on cover, insert and base



PACKAGING

Cassette packed assembled; safety pin packed separately in plastic bag



MATERIAL

- Polystyrene (PS)



COLORS

- Cover in clear; base, insert and safety pin in color

DIMENSIONS

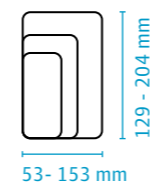

STANDARD COLORS



Product Range

Article	Suitable for	Holding devices	Index design	Outer length	Outer width	Outer depth	PU
FA 01-314	HSS drills	6	2/3/4/5/6/8mm	159mm	53mm	17mm	210
FA 01-318	Masonry drills	5	3/4/5/6/8mm	159mm	53mm	17mm	210
FA 01-320	Masonry drills	4	4/5/6/7mm	159mm	53mm	17mm	210
FA 01-323	Masonry drills	5	5/6/7/8/10mm	159mm	53mm	17mm	210
FA 01-325	Masonry drills	4	4/5/6/8mm	159mm	53mm	17mm	210
FA 01-326	Masonry drills	5	4/5/6/7/8mm	159mm	53mm	17mm	210
FA 01-327	Masonry drills	5	4/5/6/8/10mm	159mm	53mm	17mm	210
FA 01-328	Masonry drills	4	5/6/8/10mm	159mm	53mm	17mm	210
FA 01-334	Wood drills	5	4/5/6/8/10mm	159mm	53mm	17mm	210
FA 01-340	Masonry drills	4	5/7/8/10mm	159mm	53mm	17mm	210
FA 01-345	SDS drills	4	5/7/8/10mm	159mm	53mm	17mm	210
FA 01-348	SDS drills	3	5/6/8x110mm	159mm	53mm	17mm	210
FA 01-349	SDS drills	3	6/8/10x110mm	159mm	53mm	17mm	210
FA 01-354	Masonry drills	5	5/6/7/8/10mm	159mm	53mm	17mm	210
FA 01-355	Masonry drills	4	5/6/8/10mm	159mm	53mm	17mm	210
FA 01-358	SDS drills	4	5/6/8/10x110mm	159mm	53mm	17mm	210
FA 01-380	Masonry drills	5	5/32-3/16-1/4-5/16-3/8"	159mm	53mm	17mm	210
FA 01-395	HSS drills	5	4/5/6/8/10mm	159mm	53mm	17mm	210
FA 01-396	Masonry drills	5	1/8-3/16-1/4-5/16-3/8"	159mm	53mm	17mm	210
FA 01-398	HSS drills	6	3/32-1/8-5/32-3/16-1/4-5/16"	159mm	53mm	17mm	210
FA 01-439	Masonry drills	4	5/6/6/8mm	159mm	53mm	17mm	210
FA 01-470	Wood drills	5	3/5/6/9/10mm	159mm	53mm	17mm	210
FA 01-480	Masonry drills	5	3.5/4/4.8/6/6.4mm	159mm	53mm	17mm	210
FA 01-481	Masonry drills	5	3.5/4/4.8/6/6.4mm	159mm	53mm	17mm	210
FA 01-526	HSS drills	5	4/5/6/7/8mm	159mm	53mm	17mm	210
FA 01-527	Masonry drills	5	4/5/6/8/10mm, w/o length stop	159mm	53mm	17mm	210
FA 01-605	Masonry drills	5	4/5/6/8/10mm	159mm	53mm	17mm	210
FA 01-606	HSS drills	5	2/3/4/5/6mm	159mm	53mm	17mm	210
FA 01-703	Screwdriver	5	No. 3-8	159mm	53mm	17mm	210
FA 01-747	Wood drills	5	1/8-3/16-1/4-5/16-3/8"	159mm	53mm	17mm	210
FA 01-793	HSS drills	5	4/5/6/8/10mm	159mm	53mm	17mm	210
FA 01-797	HSS drills	6	2/3/4/5/6mm + 1 center punch	159mm	53mm	17mm	210
FA 01-816	Masonry drills	5	5/6/6/8/10mm	159mm	53mm	17mm	210
FA 01-835	Masonry drills	4	4/6/8/10mm	159mm	53mm	17mm	210
FA 01-843	Jigsaw blades	5		159mm	53mm	17mm	210
FA 01-844	Jigsaw blades	6		159mm	53mm	17mm	210
FA 01-846	Jigsaw blades	5	max. 125mm + 1 drill max. Ø8mm	159mm	53mm	17mm	210
FA 01-852	Masonry drills	5	5/5.5/6/6.5/7mm	159mm	53mm	17mm	210
FA 01-853	Masonry drills	5	4/5/5.5/6.5/7mm	159mm	53mm	17mm	210
FA 01-866	Masonry drills	4	5.5/6/8/10mm	159mm	53mm	17mm	210
FA 01-885	Screwdriver	5	No. 1-5	159mm	53mm	17mm	210
FA 01-894	Jigsaw blades	6	2xmetall + 4xwood B&D-shank	159mm	53mm	17mm	210
FA 01-896	Jigsaw blades	6	2xmetall + 4xwood Bosch-shank	159mm	53mm	17mm	210
FA 01-938	Wood drills	5	3/4/5/6/8mm	159mm	53mm	17mm	210
FA 02-312	HSS drills	10	1.0-10.0x1.0mm	159mm	99mm	17mm	130
FA 02-313	HSS drills	13	2.0-8.0x0.5mm	159mm	99mm	17mm	130
FA 02-319	Masonry drills	8	3/4/5/6/7/8/9/10mm	159mm	99mm	17mm	130
FA 02-323	Masonry / Wood	9	3/4/4/5/5/6/6/8/8mm	159mm	99mm	17mm	130
FA 02-329	HSS/Masonry	9	3/4/5/6/8mm + 4/5/6/8mm	159mm	99mm	17mm	130



Need more options? The secure anti-theft closure with safety pin ensures your drill sets are optimally protected

Product Range



PACKAGING

Cassette packed assembled;
safety pin packed separately
in plastic bag



MATERIAL

- Polystyrene (PS)



COLOR

- Cover in clear;
base, insert and
safety pin in color

DIMENSION

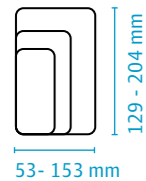

STANDARD COLOR



Article	Suitable for	Holding devices	Index design	Outer length	Outer width	Outer depth	PU
FA 02-330	HSS/Masonry	8	4/5/6/8mm + 4/5/6/8mm	159mm	99mm	17mm	130
FA 02-331	HSS/Masonry/Wood	9	4/6/8+4/6/8+4/6/8mm	159mm	99mm	17mm	130
FA 02-332	HSS/Masonry/Wood	9	5/6/8+5/6/8+5/6/8mm	159mm	99mm	17mm	130
FA 02-333	Wood drills	8	3/4/5/6/7/8/9/10mm	159mm	99mm	17mm	130
FA 02-338	Wood drills	7	3/4/5/6/8/10mm + countersink	159mm	99mm	17mm	130
FA 02-339	HSS/Masonry/Wood	9	3/4/5/5/5/6/6/8/8mm	159mm	99mm	17mm	130
FA 02-347	Masonry drills	8	3/4/5/5.5/6/6.5/8/10mm	159mm	99mm	17mm	130
FA 02-351	Masonry / Wood	9	3/4/4/5/5/6/7/8/8mm	159mm	99mm	17mm	130
FA 02-352	HSS/Masonry	9	3/4/4/5/5/6/7/8/8mm	159mm	99mm	17mm	130
FA 02-353	HSS/Masonry/Wood	9	5/5/5/6/6/7/8/8/8mm	159mm	99mm	17mm	130
FA 02-359	Masonry drills	7	3/4/5/6/8/9/10mm	159mm	99mm	17mm	130
FA 02-360	Masonry drills	8	3/4/5/6/8/9/10/12mm	159mm	99mm	17mm	130
FA 02-361	Masonry drills	7	4/5/6/7/8/9/10mm	159mm	99mm	17mm	130
FA 02-362	Masonry drills	7	3/4/5/6/7/8/10mm	159mm	99mm	17mm	130
FA 02-363	Masonry drills	8	3/4/5/6/6/8/8/10mm	159mm	99mm	17mm	130
FA 02-364	Masonry drills	7	3/4/5/6/7/8/10mm	159mm	99mm	17mm	130
FA 02-366	Masonry drills	8	4/5/5.5/6/6.5/7/8/10mm	159mm	99mm	17mm	130
FA 02-379	Masonry drills	8	4/5/5.5/6/6.5/7/8/10mm	159mm	99mm	17mm	130
FA 02-391	HSS drills	11	1/16"-3/8"x1/32"	159mm	99mm	17mm	130
FA 02-440	Masonry drills	7	3/4/5/6/7/8/10mm	159mm	99mm	17mm	130
FA 02-604	Machine taps	7	M3/M4/M5/M6/M8/M10/M12	159mm	99mm	17mm	130
FA 02-794	HSS drills	8	3/4/5/6/7/8/9/10mm	159mm	99mm	17mm	130
FA 02-833	Masonry drills	7	3/4/5/6/6/8/10mm	159mm	99mm	17mm	130
FA 02-868	Torx	8	9/10/15/20/25/27/30/40mm	159mm	99mm	17mm	130
FA 02-939	Wood drills	7	3/4/5/6/7/8/10mm	159mm	99mm	17mm	130
FA 02-950	Jigsaw blades	10		159mm	99mm	17mm	130
FA 02-953	Jigsaw blades	10		159mm	99mm	17mm	130
FA 02-9953	Jigsaw blades	10		159mm	99mm	17mm	130
FA 03-335	HSS drills	7	1.5/2/3/4/5/5.5/6mm	129mm	77mm	13mm	220
FA 03-336	HSS drills	13	1.5-6.5x0.5mm + 3.3mm + 4.2mm	129mm	77mm	13mm	220
FA 03-337	HSS drills	13	1.5-6.5x0.5mm + 3.2mm + 4.8mm	129mm	77mm	13mm	220
FA 03-392	HSS drills	7	1/16-1/4"x1/32"	129mm	77mm	13mm	220
FA 03-393	HSS drills	10	1/16-5/32x1/64+3/16-1/4"x1/32"	129mm	77mm	13mm	220
FA 03-394	HSS drills	13	1/16"-1/4"x1/64"	129mm	77mm	13mm	220
FA 03-435	HSS drills	10	1.5-6.0x0.5mm	129mm	77mm	13mm	220
FA 03-436	HSS drills	10	1.5-3x0.5+3.2+3.5+4-5x0.5+6mm	129mm	77mm	13mm	220
FA 03-490	HSS drills	7	2/2.5/3/4/5/6/6.5mm	129mm	77mm	13mm	220
FA 03-536	HSS drills	13	1.5-6.5x0.5mm + 3.3mm + 4.2mm	129mm	77mm	13mm	220
FA 03-537	HSS drills	13	1.5-6.5x0.5mm + 3.2mm + 4.8mm	129mm	77mm	13mm	220
FA 03-592	HSS drills	7	1/16-1/4"x1/32"	129mm	77mm	13mm	220
FA 03-594	HSS drills	13	1/16"-1/4"x1/64"	129mm	77mm	13mm	220
FA 03-954	Jigsaw blades	7		129mm	77mm	13mm	220
FA 03-956	Jigsaw blades	7	T-shank	129mm	77mm	13mm	220
FA 04-311	HSS drills	19	1.0-10.0x0.5mm	159mm	153mm	17mm	80
FA 04-390	HSS drills	21	1/16"-3/8"x1/64"	159mm	153mm	17mm	80
FA 04-799	HSS/Masonry/Wood	23	2-6/8+4-6/8/10+3-6/8/10+6 Bits	159mm	153mm	17mm	80
FA 04-915	HSS/Masonry/Wood	15	4/5/6/8/10mm	159mm	153mm	17mm	80
FA 04-8886	HSS drills	20	1/16"-3/8"	159mm	153mm	17mm	80
FA 05-401	SDS drills	5	5/5.5x110mm + 5.5/8/10x160mm	204mm	99mm	17mm	130



PACKAGING

Cassette packed assembled;
safety pin packed separately
in plastic bag



MATERIAL

- Polystyrene (PS)



COLORS

- Cover in clear;
base, insert and
safety pin in color

DIMENSIONS

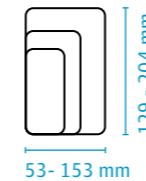

STANDARD COLORS



Product Range

Article	Suitable for	Holding devices	Index design	Outer length	Outer width	Outer depth	PU
FA 05-402	SDS drills	5	5/7x110mm + 7/8/10x160mm	204mm	99mm	17mm	130
FA 05-403	SDS drills	5	5/5.5x110mm + 6/7/8x160mm	204mm	99mm	17mm	130
FA 05-404	SDS drills	5	4.8/6.4/10.5 /12.5/14.3mm	204mm	99mm	17mm	130
FA 05-405	SDS drills	5	5/6x110mm + 6/8/10x160mm	204mm	99mm	17mm	130
FA 05-407	SDS drills	5	5/6x110mm + 8/10/12x160mm	204mm	99mm	17mm	130
FA 05-412	SDS drills	6	5/6/8x110mm + 6/8/10x160mm	204mm	99mm	17mm	130
FA 05-415	SDS drills	5	5/6/8x110mm + 6/8x160mm	204mm	99mm	17mm	130
FA 05-432	Masonry drills	8	3/4/5/6/6/8/10/12mm	204mm	99mm	17mm	130
FA 05-434	Masonry drills	7	4/5/6/7/8/10/12mm	204mm	99mm	17mm	130
FA 06-548	SDS drills	4	5/6x110mm + 6/8x160mm	204mm	53mm	17mm	210
FA 06-558	SDS drills	4	5/6x110mm + 8/10x160mm	204mm	53mm	17mm	210
FA 06-559	SDS drills	4	5x110mm + 6/8/10x160mm	204mm	53mm	17mm	210
FA 06-568	SDS drills	4	5/6/8/10x160mm	204mm	53mm	17mm	210
FA 06-569	SDS drills	3	10.5/12.5/14.3x160mm	204mm	53mm	17mm	210
FA 06-570	SDS drills	4	6/8/10/12x160mm	204mm	53mm	17mm	210
FA 06-571	SDS drills	4	5.5/6/7/8x160mm	204mm	53mm	17mm	210
FA 07-300	Bits+Magnetic holder	16	15 bits+bit holder	160.5mm	68mm	17mm	180

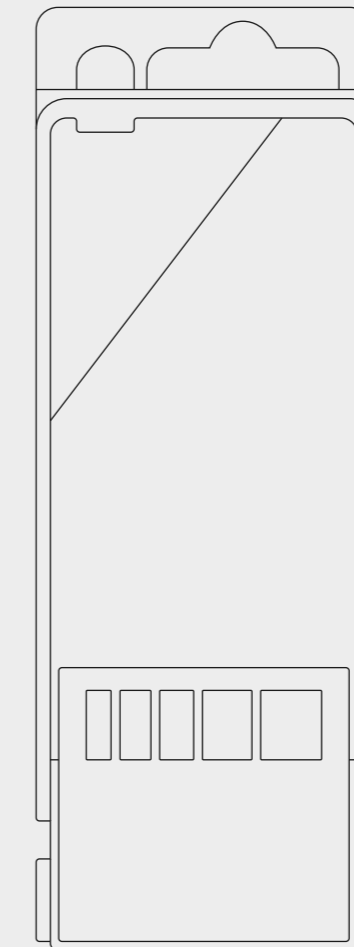

FB Cassette

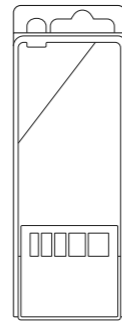

Plastic drill cassettes for all types of drill bit sets (HSS / Masonry / SDS / Wood drills etc.)

- four individual parts: cover, base, insert and safety pin
- clear hinged cover
- secure anti-theft closure with safety pin
- printing available on cover, insert and back



PACKAGING

Cassette packed assembled; safety pin packed separately in plastic bag



MATERIAL

- Polystyrene (PS)



COLORS

- Cover in clear; base, insert and safety pin in color

DIMENSIONS

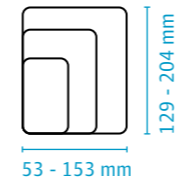

STANDARD COLORS



Product Range

Article	Suitable for	Holding devices	Index design	Outer length	Outer width	Outer depth	PU
FB 01-314	HSS drills	6	2/3/4/5/6/8mm	159mm	53mm	17mm	230
FB 01-316	HSS drills	5	2/3/4/5/6mm (Crown Point)	159mm	53mm	17mm	230
FB 01-320	Masonry drills	4	4/5/5.5/6.5mm	159mm	53mm	17mm	230
FB 01-321	Masonry drills	4	4/5/6/7mm (SpearPoint)	159mm	53mm	17mm	230
FB 01-325	Masonry drills	4	4/5/6/8mm (Point round)	159mm	53mm	17mm	230
FB 01-327	Masonry drills	5	4/5/6/8/10mm	159mm	53mm	17mm	230
FB 01-328	Masonry drills	4	5/6/8/10mm	159mm	53mm	17mm	230
FB 01-334	Wood drills	5	4/5/6/8/10mm	159mm	53mm	17mm	230
FB 01-338	Wood drills	5	4/5/6/8mm+Senker	159mm	53mm	17mm	230
FB 01-340	Diamond drills	5	4/5/6/8/10mm	159mm	53mm	17mm	230
FB 01-395	HSS drills	5	4/5/6/8/10mm	159mm	53mm	17mm	230
FB 01-397	Masonry drills	4	4/5/6/8mm SpearPoint, Hex-Shank	159mm	53mm	17mm	230
FB 01-525	Masonry drills	4	4/5/6/8mm	159mm	53mm	17mm	230
FB 01-804	HSS drills	6	1/16"-5/16"	159mm	53mm	17mm	230
FB 01-938	Wood drills	5	3/4/5/6/8mm	159mm	53mm	17mm	230
FB 02-312	HSS drills	10	1.0-10.0x1.0mm	159mm	99mm	17mm	130
FB 02-313	HSS drills	13	2.0-8.0x0.5mm	159mm	99mm	17mm	130
FB 02-319	Masonry drills	8	3/4/5/6/7/8/9/10mm	159mm	99mm	17mm	130
FB 02-329	HSS/Masonry	9	3/4/5/6/8mm+4/5/6/8mm	159mm	99mm	17mm	130
FB 02-330	HSS/Masonry	8	4/5/6/8mm+4/5/6/8mm	159mm	99mm	17mm	130
FB 02-331	HSS/Masonry/Wood	9	4/6/8+4/6/8+4/6/8mm	159mm	99mm	17mm	130
FB 02-332	HSS/Masonry/Wood	9	5/6/8+5/6/8+5/6/8mm	159mm	99mm	17mm	130
FB 02-333	Wood drills	8	3-10x1.0mm	159mm	99mm	17mm	130
FB 02-350	Masonry drills	7	4/5/6/7/8/9/10mm	159mm	99mm	17mm	130
FB 02-351	Masonry drills	7	4/5/5.5/6/7/8/10mm	159mm	99mm	17mm	130
FB 02-353	Masonry drills	7	3/4/5/6/6/8/10mm	159mm	99mm	17mm	130
FB 02-359	Masonry drills	7	3/4/5/6/8/9/10mm	159mm	99mm	17mm	130
FB 02-362	Masonry drills	8	3/4/5/6/8/9/10/12mm	159mm	99mm	17mm	130
FB 02-939	Wood drills	7	3/4/5/6/7/8/10mm	159mm	99mm	17mm	130
FB 03-336	HSS drills	13	1.5-6.5x0.5mm+3.3mm+4.2mm	129mm	77mm	13mm	220
FB 03-337	HSS drills	13	1.5-6.5x0.5mm+3.2mm+4.8mm	129mm	77mm	13mm	220
FB 03-339	HSS drills	13	1.5-6.5x0.5mm+3.2mm+4.2mm	129mm	77mm	13mm	220
FB 03-343	HSS drills	7	2/2.5/3/3.5/4/5/6mm	129mm	77mm	13mm	220
FB 03-392	HSS drills	7	1/16"-1/4"	129mm	77mm	13mm	220
FB 03-393	HSS drills	10	1/16"-1/4"	129mm	77mm	13mm	220
FB 03-394	HSS drills	13	1/16"-1/4"	129mm	77mm	13mm	220
FB 03-802	HSS drills	5	1/16"-1/4"	129mm	77mm	13mm	220
FB 04-311	HSS drills	19	1.0-10.0x0.5mm	159mm	153mm	17mm	80
FB 04-386	HSS drills	20	1/16"-3/8"	159mm	153mm	17mm	80
FB 05-360	SDS drills	4	5/6x110mm+8/10x160mm	195mm	77mm	17mm	160
FB 05-361	SDS drills	4	6/8/10/12x160mm	195mm	77mm	17mm	160
FB 05-365	SDS drills	4	5.5/7/8/10x160mm	195mm	77mm	17mm	160
FB 05-367	SDS drills	4	5/6/8x110mm+10x160mm	195mm	77mm	17mm	160
FB 05-887	SDS drills	4	1/4"-1/2"	195mm	77mm	17mm	160



Multiple sizes, one product – the perfect packaging solution for drill sets

FNKL Cassette

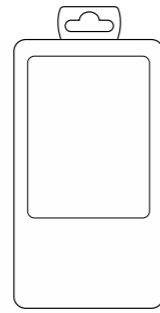

Plastic drill bit cassettes in robust, sturdy design for SDS-drills and pin punches

- four individual parts: cover, base, insert and hanger
- snap-fit holds the tools in place
- integrated anti-theft feature
- printing available on cover



PACKAGING
Packed assembled



MATERIAL
- Polypropylene (PP)



COLORS
- Available in various attractive standard colors and color combinations

USABLE LENGTHS

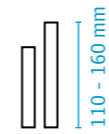

DIMENSION

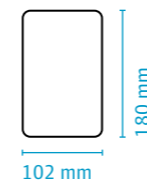

STANDARD COLORS



Product Range

Article	Suitable for	Number of holding devices	Usable length fixed	Outer length	Outer width	Outer height	PU
FNKL 1/1	Pin punches	6	160mm	180mm	102mm	22mm	100
FNKL 1/2	SDS drills	6	160mm	180mm	102mm	22mm	100
FNKL 1/3	SDS drills	6	110mm	180mm	102mm	22mm	140
FNKL 2/2	SDS drills	7	160mm	180mm	102mm	22mm	140
FNKL 2/3	SDS drills	7	110mm	180mm	102mm	22mm	140

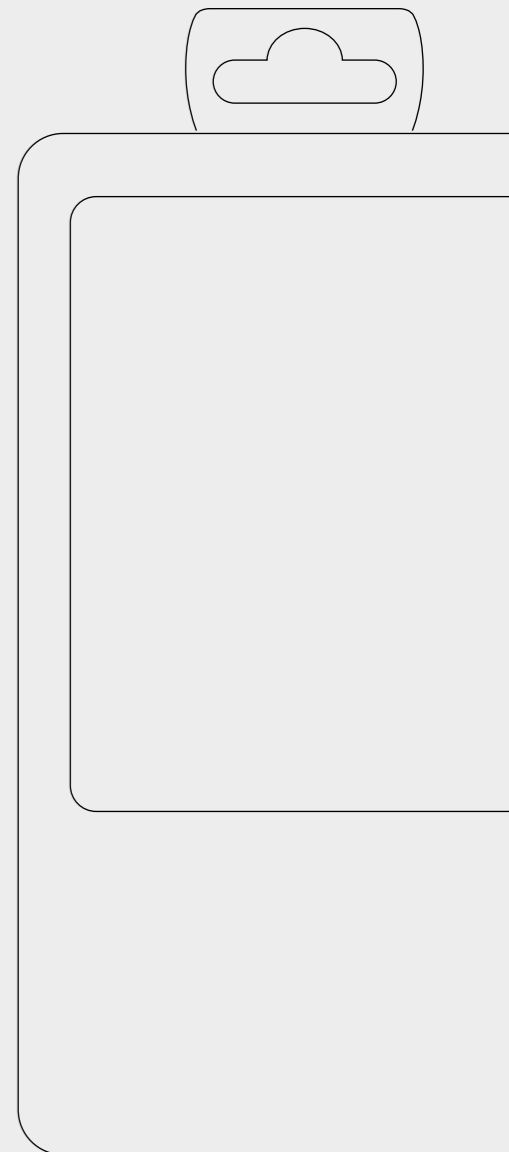

Simple and efficient – no other packaging offers better protection for SDS drills and pin punches

FNSB Cassette

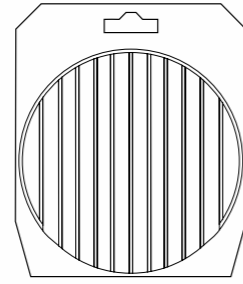

Plastic cassettes with integrated anti-theft feature for jigsaw blade set

- cost-effective packaging solution
- printing available on cover and base
- available in various sizes and versions
- two parts: cover and base



PACKAGING

Base and cover are packed separately in individual cartons



MATERIAL

- Polystyrene (PS)



COLORS

- Cover in clear
- Base in color

DIMENSIONS

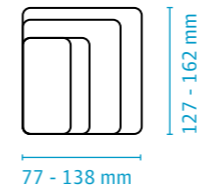

STANDARD COLORS



Product Range

Article	Suitable for	Number of holding devices	Outer length	Outer width	Outer height	PU
FNSB 9666	Jigsaw blades	6	127mm	88mm	10mm	1000
FNSB 9697	Saw blades max. length 100mm	10	127mm	102mm	10mm	1000
FNSB 9783	Jigsaw blades (80-125mm)	10	162mm	138mm	12mm	1000
FNSB 9820	Saw blades max. length 100mm	5	138mm	77mm	9mm	1000

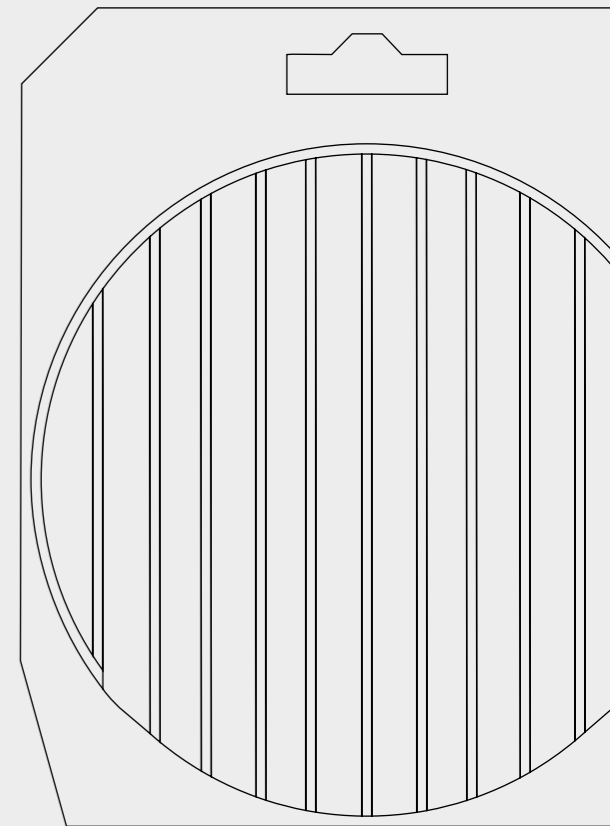

Simple, yet ingenious – this secure packaging ensures your jigsaw blade sets are perfectly protected

GripBox

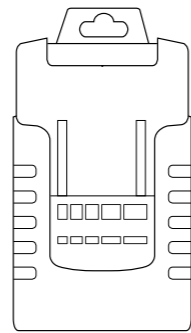

...has a firm grip on your tools! Plastic drill cassettes for drill bit sets (HSS drill sets DIN 338, machine tap sets DIN 371/376 etc.)

- four parts: cover, base, insert and safety pin
- sturdy and modern design with ergonomic body design
- clear cover allows for product visibility
- integral designed hanging loop
- twist off anti-theft locking pin
- cover and base with integral tool stop
- easy, efficient handling
- excellent for stacking and storage



PACKAGING
Cassette packed assembled;
safety pin packed separately
in plastic bag



MATERIAL
- Base and insert:
Polypropylene (PP)
- Cover: Polystyrene (PS)



COLORS
- Cover in clear
- Base, insert and safety
pin in color

DIMENSIONS

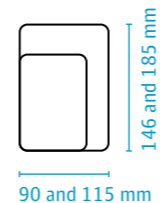

STANDARD COLORS



Product Range

Article	Suitable for	Holding devices	Index design	Standard-ization	Outer length	Outer width	Outer height	PU
GB 3A 07/01	Machine taps	7	M3-M12	DIN 371/ DIN376	146mm	90mm	37mm	70
GB 3A 07/02	HSS drills	7	1/4"3/16"9/64" 1/8"7/64"3/32"		146mm	90mm	37mm	70
GB 3A 07/03	Machine taps	7	M3-M12	JIS	146mm	90mm	37mm	70
GB 3A 14/01	Machine taps	14	M3-M12 +core hole drill	DIN 371/ DIN376	146mm	90mm	37mm	70
GB 3A 14/02	HSS drills	14	1.5-6.5x0.5+3.2 +4.8+ holder		146mm	90mm	37mm	70
GB 3A 14/03	HSS drills	14	1/16"-1/4"x1/64"+holder		146mm	90mm	37mm	70
GB 3A 19/01	HSS drills	19	1-10mmx0.5mm	DIN 338	146mm	90mm	37mm	70
GB 3A 20/01	HSS/Masonry/ Wood	20	4/5/6/8+HSS1-6.5x0.5		146mm	90mm	37mm	70
GB 3A 21/01	HSS drills	21	1/16"-3/8"x1/64"	DIN 338	146mm	90mm	37mm	70
GB 4A 07/01	SDS drills	7	5/6/8x110+ 6/8/10/12x160		185mm	115mm	40mm	50
GB 4B 25/01	HSS drills	25	1-13mmx0.5mm	DIN 338	185mm	115mm	63mm	30
GB 4B 25/02	HSS drills	25	1-13mmx0.5mm	DIN 338	185mm	115mm	63mm	30
GB 4B 29/01	HSS drills	29	1/16"-1/2"x1/64"	DIN 338	185mm	115mm	63mm	30

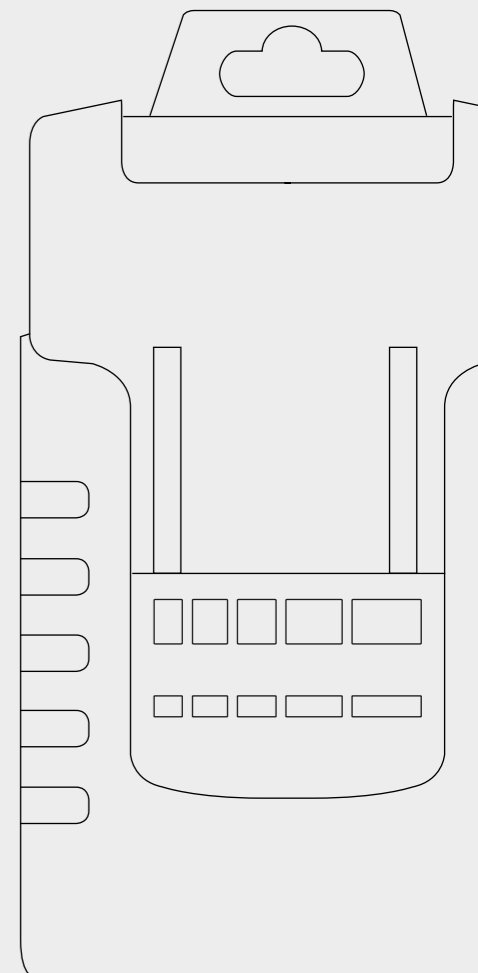

Everything under control – this packaging solution not only perfectly protects drill sets, but also guarantees a stunning appearance thanks to its attractive design

Rose Box

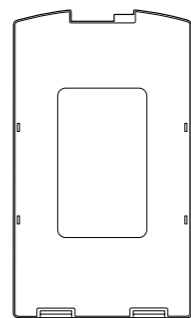

High-quality plastic cassettes in modern design. Ideal for all kinds of drill bit sets, precision tools, shank tools, special tool sets and spare parts

- modular concept – cassettes can be combined with individual foam inserts or vacuum formed inserts
- intergral secure locking mechanism to prevent unintended opening on impact
- adjustable and flexible length stop for tools
- modern design
- functional and user-friendly
- universal application
- resilient and stable
- excellent for stacking and storage
- space for labelling on cover and base
- optional with intergrated clear window in cover for optimum product presentation



PACKAGING
Packed assembled



- MATERIAL**
- Cover, base and length stop in ABS
 - Insert, closure and hanger in Polypropylene (PP)
 - Hinges in Polyamide (PA)



- COLORS**
- Bases in light gray
 - Cover, closure and hanger in dark gray
 - Insert and length stop in black
 - Additional colors and color combinations on request

DIMENSIONS

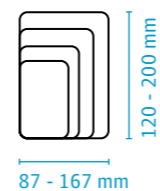

STANDARD COLORS



Product Range

Article	Holding devices	Suitable for	Index design	Standard-ization	Outer lenght	Outer width	Outer depth	PU
1A 87	30	Bits+Magnetic holder	30 Bits+Magnetic holder Ø 10mm		120	87	36	90
2B 11	3	Sheet and tube drills	3-14/8-20/16-30.5		146	100	42	54
3A 68	3	Sheet and tube drills	3-14/8-20/16-30.5+ cutting compound		172	115	42	65
3A 33	15	Spiral point taps	each machine tap M3-M12+each 1 core hole drill 2.5/3.3/4.2/5/6.8/8.5/10.2+1 tapwrench	DIN 352	172	115	42	65
2B 24	4	Deburring countersinks	2-5/5-10/10-15/15-20		146	100	42	54
3A 60	5	Deburring countersinks	2-5/5-10/10-15/15-20/20-25		172	115	42	65
2B 58	6	Flat counterbores	M3/M4/M5/M6/M8/M10	DIN 373	146	100	42	54
2B 85	5	Rotary burrs	Shank-diam. 6mm; 5 diff. head diameters, length 71mm		146	100	42	54
2B 22	10	Rotary burrs	Shank-diam. 6mm; 10 diff. head diameters		146	100	42	54
2B 90	10	Rotary burrs	Shank-diam. 6mm; 10 diff. head diameters, length 71mm		146	100	42	54
1A 88	7	Threading dies	M3-M12		120	87	36	90
4A 08	7	SDS drills	5.0x110/6.0x110/6.0x160/8.0x110/8.0x160/10.0x160/12.0x160 (SDS-Plus-Shaf)		200	115	42	60
3A 20	21	Hand taps	1 set (3) each hand taps M3/M4/M5/M6/M8/M10/M12	DIN 352	172	115	42	65
3A 43	21	Hand taps	1 set (3) each hand taps M3/M4/M5/M6/M8/M10/M12	ISO 529	172	115	42	65
4B 107	21	Hand taps	1/8. 3/16. 1/4. 5/16. 3/8. 7/16. 1/2 BSW // 3/16-1/2 UNC. UNF. BSF	DIN 338	200	115	58	38
4B 41	28	Hand taps	1 set (3) each hand taps M3-M12+each 1 drill 2.5/3.3/4.2/5/6.8/8.5/10.2	DIN 352	200	115	58	38
4B 54	28	Hand taps	1 set (3) each hand taps M3-M12+each 1 drill 2.5/3.3/4.2/5/6.8/8.5/10.2	DIN 335-C	200	115	58	38
2B 106	11	HSS drills	1.0-6.0x0.5mm	DIN 338	146	100	42	54
2B 103	13	HSS drills	1/16"-1/4"x1/64"	ANSI Jobber Length/ DIN 338	146	100	42	54
3A 117	19	HSS drills	1.0-10.0x0.5mm	DIN 338	172	115	42	65
3A 06	21	HSS drills	1/16"-3/8"x1/64"	DIN 338	172	115	42	65
4A 05	15	HSS drills	1/16"-1/2"x1/32"	DIN 338	200	115	42	60
4B 09	24	HSS drills	1.0-10.5x0.5mm+core hole drills 3.3/4.2/6.8/10.2	DIN 338	200	115	58	38
4B 03	25	HSS drills	1.0-13.0x0.5mm	DIN 338	200	115	58	38
4B 105	26	HSS drills	Letter Gauge Drills A-Z (Jobber Length) (ASME B94.11 M)		200	115	58	38
4B 07	29	HSS drills	1/16"-1/2"x1/64"	DIN 338	200	115	58	38
4B 95	29	HSS drills	1.0-13.0x0.5mm+core hole drills 3.3/4.2/6.8/10.2	ISO 529	200	115	58	38
4B 36/8	50	HSS drills	1.0-5.9x0.1mm	ISO 529	200	115	58	38
4B 36	51	HSS drills	1.0-6.0x0.1mm	DIN 338	200	115	58	38
5B 72	41	HSS drills	6.0-10.0x0.1mm	DIN 338	200	167	65	24
5B 104	60	HSS drills	Wire Gauge Drills 1-60 (ASME B94.11 M)		200	167	65	24



The practical packaging solution offers maximum product protection for diverse applications

Product Range



PACKAGING

Packed assembled



MATERIAL

- Cover, base and length stop in ABS
- Insert, closure and hanger in Polypropylene (PP)
- Hinges in Polyamide (PA)



COLORS

- Bases in light gray
- Cover, closure and hanger in dark gray
- Insert and length stop in black
- Additional colors and color combinations on request

DIMENSIONS

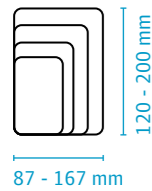

STANDARD COLORS



Article	Holding devices	Suitable for	Index design	Standard-ization	Outer length	Outer width	Outer depth	PU
3A 83	19	HSS short drills	1.0-10.0x0.5mm	DIN 1897	172	115	42	65
2B 78	5	Countersinks	6.3/10.4/16.5/20.5/25	DIN 335-C	146	100	42	54
2B 12	6	Countersinks	6.3/8.3/10.4/12.4/16.5/20.5	DIN 335-C	146	100	42	54
2B 13	6	Countersinks	6/8/10/11.5/15/19	DIN 335-C	146	100	42	54
2B 14	6	Countersinks	6.3/8.3/10.4/12.4/16.5/20.5 lang	DIN 335-C	146	100	42	54
2B 69	7	Countersinks	6/8/10/11.5/15/19/25	DIN 335-C	146	100	42	54
4A 88	6	Countersinks	6.3-20.5 with extra long shank	DIN 335-C	200	115	42	60
4B 62	17	Countersinks	4.3/5/6/6.3/7/8/8.3/10/10.4/11.5/12.4/15/16.5/19/20.5/23/25	DIN 338	200	115	58	38
3A 74	7	Countersinks-Bits	6 countersink bits 6.3/8.3/10.4/12.4/16.5/20.5 mm+bit holder Ø 1/4". handle and cutting compound	DIN 3126 C 6.3	172	115	42	65
1A 80	6	Combined tap and drills+ magnetic holder	6 combined tap and drill bits (M3-M12)+magnetic holder Ø 10mm		120	87	36	90
2B 35	7	Machine taps	M3-M12	DIN 371/376	146	100	42	54
3A 10	14	Machine taps	each machine tap M3-M12+core hole drill 2.5/3.3/4.2/5/6.8/8.5/10.2	DIN 371/376	172	115	42	65
3A 89	14	Machine taps	each machine tap M3-M12+core hole drill 2.5/3.3/4.2/5/6.8/8.5/10.2	ISO 529	172	115	42	65
3A 76	10/12	Screwdriver	5 screwdrivers+5 drills for M3-M18 (1/8"-3/4") or 6 screwdrivers+ 6 drills M3-M24 (1/8"-1")		172	115	42	65
2B 30	6	Countersink bits HSS	6.3/8.3/10.4/12.4/16.5/20.5+ bit holder Ø 1/4"	DIN 3126 C 6.3	146	100	42	54
2B 21	3	Step drills	4-12/12-20/20-30		146	100	42	54
2B 23	3	Step drills	4-12/4-20/6-30		146	100	42	54
3A 71	3	Step drills	4-12/12-20/20-30+ cutting compound		172	115	42	65
4A 37	6	Pin punches	2/3/4/5/6/8	DIN 6450 C	200	115	42	60
4A 29	7	Masonry drills	4.0/5.0/6.0/6.0/8.0/10.0/12.0	DIN 8039	200	115	42	60



Transport & Storage systems

Everything in perfect order

The bottom line is that your customers want products that are safe, clean, and well organized. And YOU want your customers to come back – not your products. Our sturdy and safe transport and organizing systems are the perfect way to create order from chaos – while optimally protecting your products.



AQRADO

Versatile drawer storage system for garage workshop, laboratory, office and home – modular, customized and installed in seconds!
more on page 158

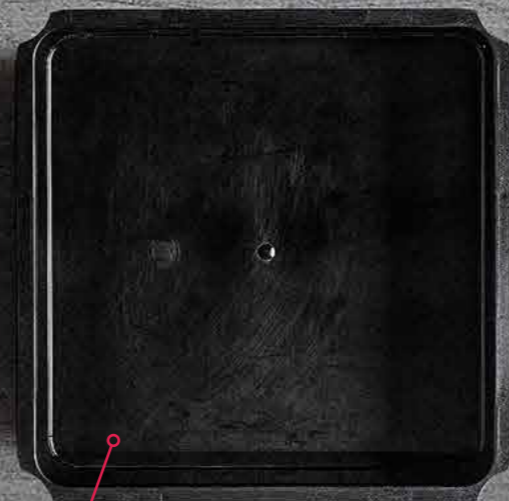

StorePack

Smart packaging, sales promotion and storage system in one solution – perfectly organized and safely stored.
more on page 164

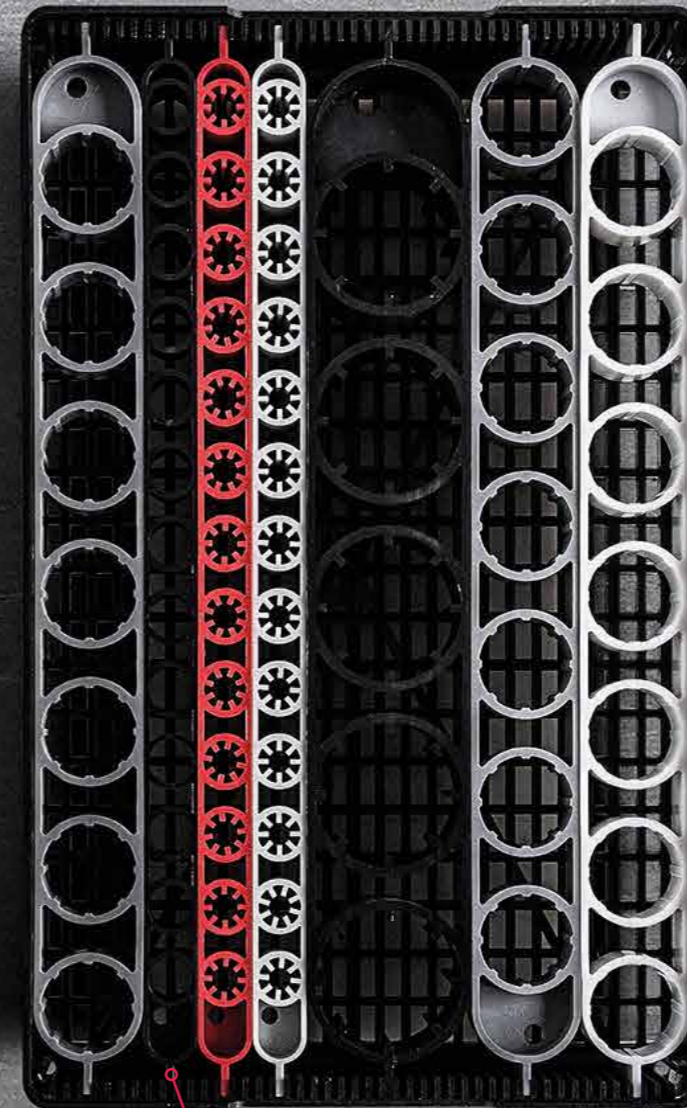

SystemBoard

Transport and storage container in modular design for organized storage and safe transportation of cutting tools
more on page 166



LogisticSystem

One box – countless possibilities! Packaging system for safe storage and transportation of tools during reconditioning
more on page 162

PLEASE
INQUIRE FOR
INDIVIDUAL DRAWER
SETS IN SMALL
QUANTITIES

AQRADO®

Versatile drawer storage system for garage workshop, laboratory, office and home – modular, customized and installed in seconds!

- wide product range to suit individual applications
- suitable for every drawer size
- neat arrangement means quick access and efficient working
- perfect protection of instruments and tools
- numerous modules for universal application as well as for special items such as calipers, socket sets, spanners, drills, laboratory equipment and stationery...
- base pad can be cut in all sizes in 24 mm increment spacings
- excellent for stacking and storage



PACKAGING

Parts are packed separately in individual cartons



MATERIAL

- Modules: Polystyrene (PS)
- Base pad: ABS



COLORS

- Standard color black and gray



ACCESSORIES

- Cutting guide/aid
- Multi-purpose knife
- Adhesive pads
- Label tab
- Eccentric fixing pins
- Assembly kit
- Cover
- Divider

OUTER DEPTHS

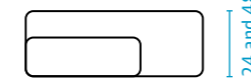

OUTER DIMENSIONS

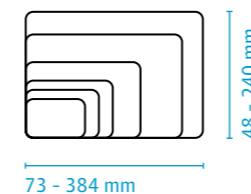

STANDARD COLORS



Product Range

Aqurado Sets

Article	Description	Outer length	Outer width	Outer height	PU
AQ-Set 5443	12 modules + base pad	600mm	408mm	24mm	1
AQ-Set 5444	11 modules + base pad	600mm	576mm	48mm	1
AQ-Set 5445	20 modules + base pad	600mm	600mm	48mm	1
AQ-Set 5446	24 modules + base pad	528mm	480mm	24mm	1

Aqurado Modules

Article	Description	Outer length	width	height	PU
AQ-Multi 0102	3 compartments	192mm	96mm	24mm	84
AQ-Multi 0103	2 compartments	288mm	96mm	24mm	56
AQ-Multi 0113	8 compartments	192mm	144mm	24mm	56
AQ-Spezial 2110	for 12 open-end/ring spanners	336mm	240mm	48mm	9
AQ-Spezial 2111	for 8 double-ended ring wrench	336mm	240mm	48mm	9
AQ-Spezial 2112	hex key 1.5/2/2.5/3/4/5/6/8/10	288mm	96mm	24mm	20
AQ-Spezial 2113	for calipers	288mm	96mm	24mm	20
AQ-Spezial 2114	for 6 screw drivers	384mm	144mm	48mm	14
AQ-Spezial 2115	for twist drills (1.0-6.0 mm)	144mm	144mm	48mm	12
AQ-Spezial 2116	for twist drills (6.1-10.0 mm)	192mm	144mm	48mm	8
AQ-Spezial 2117	for multi-media, for 11 CDs	192mm	144mm	48mm	8
AQ-Spezial 2118	for 10 collets (ER 16)	144mm	96mm	48mm	16
AQ-Spezial 2119	for 16 collets (ER 25)	288mm	96mm	48mm	8
AQ-Spezial 2120	for 12 collets (ER 32)	288mm	96mm	48mm	8
AQ-Spezial 2121	for 12 collets (444 E)	288mm	96mm	48mm	8
AQ-Spezial 2122	for 13 collets (ER 40)	336mm	96mm	48mm	9
AQ-Spezial 2123	for socket sets (22 pcs.)	384mm	144mm	48mm	14
AQ-Uni 0100		96mm	48mm	24mm	120
AQ-Uni 0101		96mm	96mm	24mm	60
AQ-Uni 0104		192mm	96mm	24mm	84
AQ-Uni 0105		96mm	96mm	48mm	84
AQ-Uni 0106		192mm	96mm	48mm	72
AQ-Uni 0107		240mm	96mm	48mm	57
AQ-Uni 0108		288mm	96mm	48mm	48
AQ-Uni 0109		336mm	96mm	48mm	39
AQ-Uni 0110		288mm	96mm	24mm	56
AQ-Uni 0111		144mm	96mm	48mm	56
AQ-Uni 0112		144mm	96mm	24mm	40
AQ-Uni 0114		384mm	144mm	48mm	24
AQ-Uni 0115		336mm	240mm	48mm	15
AQ-Uni 0116		144mm	144mm	48mm	64
AQ-Uni 0117		192mm	144mm	48mm	48
AQ-Uni 0118	module for 5 dividers	144mm	144mm	48mm	64
AQ-Uni 0119	module for 7 dividers	192mm	144mm	48mm	48
AQ-Uni 0120	module for 15 dividers	384mm	144mm	48mm	24
AQ-Uni 0121		192mm	72mm	48mm	56
AQ-Uni 0122		192mm	72mm	24mm	40
AQ-Vario 1114	end-piece, 8 compartments	192mm	48mm	24mm	60
AQ-Vario 1115	end-piece, 8 compartments	192mm	73mm	24mm	40
AQ-Vario 1116	end-piece, 3 compartments	96mm	96mm	24mm	60
AQ-Vario 1117	end-piece, 2 compartments	96mm	96mm	24mm	60
AQ-Vario 1118	end-piece, 1 compartments	73mm	48mm	24mm	80
AQ-Vario 1119	end-piece, 1 compartments	96mm	96mm	24mm	60
AQ-Vario 1121	end-piece, 1 compartments	92mm	72mm	48mm	32
AQ-Vario 1122	end-piece, 1 compartments	92mm	72mm	24mm	80

Vario modules: two parts needed



Compartmentalized thinking can sometimes make sense - if it ensures perfect organization

Product Range



PACKAGING

Parts are packed separately in individual cartons



MATERIAL

- Modules: Polystyrene (PS)
- Base pad: ABS



COLORS

- Standard color
- black and gray



ACCESSORIES

- Cutting guide/aid
- Multi-purpose knife
- Adhesive pads
- Label tab
- Eccentric fixing pins
- Assembly kit
- Cover
- Divider

INNER DEPTHS



INNER DIMENSIONS

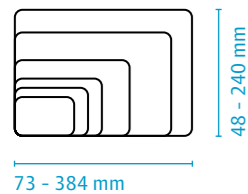

STANDARD COLORS



Aqurado accessories

Article	Description	Outer length	Outer width	Outer height	PU
AQ-Extra 4100	cutting guide/aid				25
AQ-Extra 4101	multi-purpose knife				60
AQ-Extra 4102	adhesive pads (6 pcs.)				25
AQ-Extra 4103	adhesive pads (34 pcs.)				50
AQ-Extra 4104	label tab (vertical)	45mm	13mm		50
AQ-Extra 4105	label tab (horizontal)	48mm	15mm		50
AQ-Extra 4107	eccentric fixing pins				20
AQ-Extra 4390	assembly kit				10
AQ-Extra 4400	cover	96mm	96mm		10
AQ-Extra 4401	cover	96mm	48mm		10
AQ-Extra 4402	cover	144mm	96mm		10
AQ-Extra 4403	cover	192mm	96mm		10
AQ-Extra 4500	divider			60mm	10
AQ-Extra 4501	divider			100mm	10

Aqurado base pad

Article	Outer length	Outer width	PU
AQ-Base 3907	1584mm	624mm	16

Logistic Box

Transport box with handle for heavy items

- Ergonomically shaped handle allows carrying the box close to the body, thus protecting the back.
- The detachable lid with snap lock makes it easier to safely pour out the contents.
- The Logistic Box can be stacked and palletized both empty and full.
- Individual customization through printing for clear organization.
- Flexible fitting with inserts or foams possible, allowing it to be individually adapted for different applications.



Product Range

Article	Outer dimensions H x W x D	PU
LB 185	18.5 x 21 x 15cm	20



PACKAGING

Carton



MATERIAL

- Polypropylene (PP)
- Recyclate rPP 63 (gray)



COLORS

- black
- gray

STANDARD COLORS



LogisticSystem

One box – countless possibilities! Packaging system for safe storage and transportation of tools during reconditioning

Boxes

- available in three sizes with padded lid
- boxes 175 and 235 can be combined with the rose plastic SystemBoard
- standardized, stable and stackable box system
- can be labeled and combined with an optional trolley

SystemBoard

- ideal for sorting, organizing and transporting of tools
- automatable, flexible system with various adjustable inserts
- suitable for immersion baths for cleaning and coating

Foam Trays

- flexible for use with different tool lengths and diameters
- made of high-strength material, with recessed grips
- adjustable separators for different tool lengths
- lower risk of injury due to lying transport of tools
- can be laser-engraved with a minimum quantity of 50 pieces



PACKAGING

Parts are packed separately in individual cartons



MATERIAL

- Box, lid and latches in Polypropylene (PP), scratch-resistant
- Trolley in ABS
- Stable, durable and water-resistant foam with high density



COLORS

- Boxes in light gray
- Trolley in red
- Foam in black
- Separators in red



ACCESSORIES

- Trolley
- Separators
- Foam Trays
- SystemBoard (see page 166)
- SystemBoard fixing set

OUTER DEPTHS

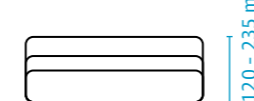

OUTER DIMENSION

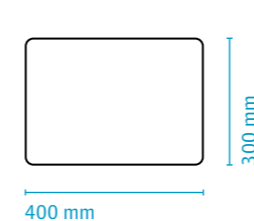

STANDARD COLORS



Product Range

LogisticSystem

Article	Description	Outer length	Outer width	Outer height	PU
F-RLSBX-SE 120 K	Box 120 incl. foam lid	400mm	300mm	120mm	1
F-RLSBX-SE 175 K	Box 175 incl. foam lid	400mm	300mm	175mm	1
F-RLSBX-SE 235 K	Box 235 incl. foam lid	400mm	300mm	235mm	1
RLSW	Trolley	620mm	420mm	155mm	1

LogisticSystem foam trays

Article	Description	Outer length	Outer width	Outer height	PU
SE RLS 10	Separators for foam trays	316mm	17mm	10mm	10
SE RLS 32/14 14 A.	Foam tray with 14 slots	356mm	255mm	32mm	1
SE RLS 32/20 10 A.	Foam tray with 10 slots	356mm	255mm	32mm	1
SE RLS 40	SystemBoard fixing set	360mm	60mm	40mm	1



Finally – a way to ensure everything is neatly squared away! Contains 100% pure organization

StorePack

Smart packaging, sales promotion and storage system in one solution – perfectly organized and safely stored

- modular packaging, sales and organization system
- sustainable packaging with the additional benefit of an organization system
- wide product range to suit individual applications
- suitable for every drawer size
- modules can be simply assembled onto the base pad with just one "click"
- selected modules are available with hangers and covers – ideal for the sale of products that are packed in modules at the Point of Sale
- combine with the RoseCassette to create a practical assortment box – keeps the contents safe and well organized during transportation
- stackable due to the special base contour



PACKAGING

Parts are packed separately in individual cartons



MATERIAL

- Module and base pad: ABS
- Transparent cover: PET



COLORS

- Standard color
- black and white



ACCESSORIES

- Multi-purpose knife
- Cutting guide/aid
- Assembly kit
- Adhesive pads
- RoseCassette (see page 134)

INNER DEPTHS



INNER DIMENSION

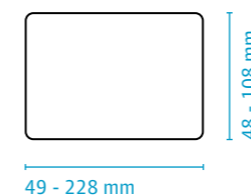

STANDARD COLORS



Product Range

StorePack modules

Article	Description	Outer width	Outer height	Outer depth	Inner length	Inner width	Inner depth	PU
STPU-A 60x60x25/1 B	with hanger	78mm	59mm	26mm	49mm	49mm	22mm	420
STPU-A 90x60x25/1 B	with hanger	108mm	59mm	26mm	79mm	49mm	22mm	330
STPU-A 120x60x25/1 B	with hanger	138mm	59mm	26mm	109mm	49mm	22mm	240
STPU 60x60x25/1 B	without hanger	59mm	59mm	26mm	49mm	49mm	22mm	380
STPU 60x60x50/1 B	without hanger	59mm	59mm	49mm	49mm	48mm	44mm	180
STPU 90x60x25/1 B	without hanger	89mm	59mm	26mm	79mm	49mm	22mm	252
STPU 90x60x50/1 B	without hanger	89mm	59mm	49mm	79mm	48mm	44mm	120
STPU 90x90x50/1 B	without hanger	89mm	89mm	49mm	79mm	78mm	44mm	128
STPU 120x60x25/1 B	without hanger	119mm	59mm	26mm	109mm	49mm	22mm	300
STPU 120x60x50/1 B	without hanger	119mm	59mm	49mm	109mm	48mm	44mm	150
STPU 120x90x50/1 B	without hanger	119mm	89mm	49mm	109mm	78mm	44mm	100
STPU 120x120x50/1 B	without hanger	119mm	119mm	49mm	109mm	108mm	44mm	75
STPU 180x90x50/1 B	without hanger	179mm	89mm	49mm	168mm	78mm	44mm	64
STPU 240x90x50/1 B	without hanger	239mm	89mm	49mm	228mm	78mm	44mm	48

Using a cover reduces the usable inner height by approx. 4mm

StorePack cover

Article	Outer width	Outer height	Outer depth	PU
STPU 120x60/1 C	119mm	59mm	4.5mm	2500
STPU 120x90/1 C	119mm	89mm	4.5mm	3200
STPU 120x120/1 C	119mm	119mm	4.5mm	3200

StorePack base pad

Article	Outer length	Outer width	PU
STPB 300x206/1	300mm	206mm	1
STPB-S 330x450/1	330mm	450mm	1
STPB-S 465x450/1	465mm	450mm	1
STPB-S 600x450/1	600mm	450mm	1
STPB 930x450/1	930mm	450mm	1

StorePack accessories

Article	Description	PU
D-STPE 4101	multi-purpose knife	1
STPE 4100	cutting guide/aid	1200
STPE 4390	assembly kit	50
AQ-Extra 4102	adhesive pads (6 pcs.)	25

Awards



System Board

Transport and storage container in modular design for organized storage and safe transportation of cutting tools

- interchangeable inserts (diam. 3-40 mm) offer options for customizing
- precise positioning allows automatic loading and unloading
- usable depth 25 mm or 40 mm simply by reversal of inserts
- stackable, fits for stock and transport boxes
- sturdy design, combined with impact resistant material ensures protection against damage
- intermediate frame 400 B for long parts
- suitable for immersion baths for cleaning and coating
- temperature resistant (up to 120 degrees Celsius)
- solvent resistant



PACKAGING

Parts are packed separately in individual cartons



MATERIAL

- Polyamid (PA 6)



COLORS

- Frames and intermediate frames in black
- Inserts in various colors
- Pegboards in black



ACCESSORIES

- LogisticSystem (see page 162)

SHANK DIAM.

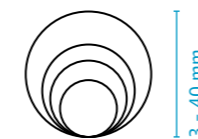

DIMENSION

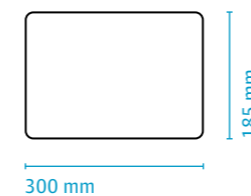

STANDARD COLORS



Product Range

SystemBoard frames

Article	Description	Outer length	Outer width	Outer height	PU
SystemBoard 400A	frame with bottom	300mm	185mm	57mm	25
SystemBoard 400B	intermediate frame w/o bottom	300mm	185mm	57mm	25

SystemBoard inserts

Article	Shank diam.	Shank diam. (in.)	Number of holding devices	Height of inserts	max. number of inserts/frames	PU
Systemboard 401-3 GF	3mm		13	25mm	12	100
Systemboard 401-1/8" GF	3.175mm	1/8	13	25mm	12	100
Systemboard 401-4 GF	4mm		13	25mm	12	100
Systemboard 401-5 GF	5mm		13	25mm	12	100
Systemboard 401-6 GF	6mm		13	25mm	12	100
Systemboard 401-1/4" GF	6.35mm	1/4	13	25mm	12	100
Systemboard 401-7 GF	7mm		13	25mm	12	100
Systemboard 401-8 GF	8mm		13	25mm	12	100
Systemboard 401-9 GF	9mm		13	25mm	12	100
Systemboard 401-3/8" GF	9.53mm	3/8	13	25mm	12	100
Systemboard 401-10 GF	10mm		13	25mm	12	100
Systemboard 401-11 GF	11mm		13	25mm	12	100
Systemboard 401-12 GF	12mm		13	25mm	12	100
Systemboard 405-12 GF	12mm		7	25mm	6	50
Systemboard 405-1/2" GF	12.7mm	1/2	7	25mm	6	50
Systemboard 405-13 GF	13mm		7	25mm	6	50
Systemboard 405-14 GF	14mm		7	25mm	6	50
Systemboard 405-15 GF	15mm		7	25mm	6	50
Systemboard 405-16 GF	16mm		7	25mm	6	50
Systemboard 405-17 GF	17mm		7	25mm	6	50
Systemboard 405-18 GF	18mm		7	25mm	6	50
Systemboard 405-19 GF	19mm		7	25mm	6	50
Systemboard 405-3/4" GF	19.05mm	3/4	7	25mm	6	50
Systemboard 405-20 GF	20mm		7	25mm	6	50
Systemboard 405-21 GF	21mm		7	25mm	6	50
Systemboard 405-22 GF	22mm		7	25mm	6	50
Systemboard 405-23 GF	23mm		7	25mm	6	50
Systemboard 405-24 GF	24mm		7	25mm	6	50
Systemboard 405-25 GF	25mm		7	25mm	6	50
Systemboard 405-1" GF	25.4mm	1	7	25mm	6	50
Systemboard 405-26 GF	26mm		7	25mm	6	50
Systemboard 407-28 GF	28mm		5	25mm	4	25
Systemboard 407-30 GF	30mm		5	25mm	4	25
Systemboard 407-32 GF	32mm		5	25mm	4	25
Systemboard 407-34 GF	34mm		5	25mm	4	25
Systemboard 407-36 GF	36mm		5	25mm	4	25
Systemboard 407-38 GF	38mm		5	25mm	4	25
Systemboard 407-40 GF	40mm		5	25mm	4	25
Systemboard 412 GF	17x17mm		28	8mm	4	100

SystemBoard pegboards

Article	Length	PU
SystemBoard Pegboards 422	178mm	300
SystemBoard Pegboards 437	297mm	250

SZS-Stands

Plastic storage tray for ER collets

- for 14, 16, 18 or 20 ER collets
- sturdy, safe, oil-resistant
- economical alternative to wooden stands



Product Range

Article	Suitable for	Number of holding devices	Outer length	Outer width	Outer height	PU
SZSER 8/16	ER 8	16	220mm	60mm	25mm	70
SZSER 11/16	ER 11	16	220mm	60mm	25mm	70
SZSER 16/16	ER 16	16	220mm	60mm	25mm	70
SZSER 20/16	ER 20	16	220mm	60mm	25mm	70
SZSER 25/20	ER 25	20	220mm	154mm	28mm	55
SZSER 32/18	ER 32	18	345mm	100mm	30mm	48
SZSER 32/20	ER 32	20	220mm	154mm	28mm	50
SZSER 40/14	ER 40	14	345mm	100mm	30mm	48



 **PACKAGING**
Carton

 **MATERIAL**
- Polystyrene (PS)

 **COLOR**
- Standard color black

STANDARD COLOR





Hangers & Accessories

What else do you need?

From hangers, end caps, and foam inserts to protective caps and Eurohole hangers – our accessories make our versatile plastic packaging even more effective.

Protective EndCaps PSC

Protective caps for polygonal taper shank tool holders according to ISO 26623-1
more on page 178



ToolHolder

Safer transport of tool holding fixtures
more on page 186

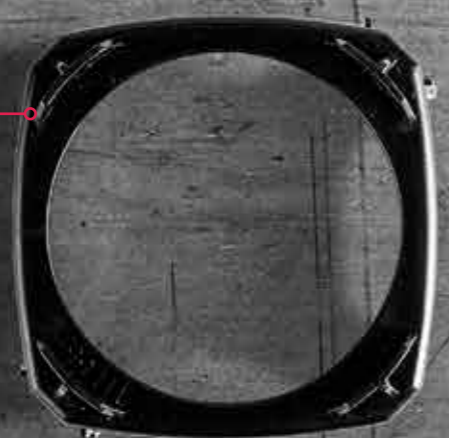

SDS-Clip

Plastic euro hangers for in-store display of masonry drills, chisels and drill bits
more on page 185



DIY-Perforated Disc

Plastic euro hanger with perforated disc
more on page 174



Foam Inserts

Foam inserts for rose plastic tubes and boxes
more on page 180





BlockPack Hanger

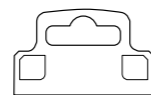

Separate hanger caps for the BlockPack packaging tubes

- separate hanger caps can be clipped on the bottom of the BlockPack outer and inner part
- for filling weights up to 2,5 kg (fixing at the outer part, static load)
- hanger available for BK 14, 20, 26, 32, 35, 45 and 55



Product Range

Article	Suitable for	max. filling weight	PU
BK 14/1	BK 14 in PE/PP	1kg	500
BK 14/2	BK 14 in PVC	1kg	500
BK 20/1	BK 20 in PE/PP	1kg	500
BK 20/2	BK 20 in PVC	1kg	500
BK 22/1	BK 22 in PE/PP	1kg	500
BK 22/2	BK 22 in PVC	1kg	500
BK 26/1	BK 26 in PE/PP	2kg	500
BK 26/2	BK 26 in PVC	2kg	500
BK 32/1	BK 32 in PE/PP	2kg	500
BK 32/2	BK 32 in PVC	2kg	500
BK 35/1	BK 35 in PE/PP	2.5kg	500
BK 35/2	BK 35 in PVC	2.5kg	500
BK 45/1	BK 45 in PE/PP	2.5kg	500
BK 55/1	BK 55 in PE/PP	2.5kg	500
BK 55/2	BK 55 in PVC	2.5kg	500



PACKAGING
Carton



MATERIAL
- Polyethylene (PE)
- Polypropylene (PP)
- Recycled plastic



COLORS
- Depending on the material transparent, natural or in various attractive standard colors



ACCESSORIES
- BlockPack (see page 14)

STANDARD COLORS



BlockPack EndCaps



End caps for additional protection of sharp objects

- prevents the content from penetrating
- made from impact resistant ABS
- end caps can be clipped on the bottom of the BlockPack outer and inner part
- end caps available for BK 32, 45, 65 and 85
- only suitable for BlockPack in PVC



Product Range

Article	Suitable for	PU
BKEC-P 32/2	BK 32 in PVC	1000
BKEC-P 45/2	BK 45 in PVC	500
BKEC-P 65/2	BK 65 in PVC	250
BKEC-P 85/2	BK 85 in PVC	140



PACKAGING
Carton



MATERIAL
- Impact resistant ABS plastics



COLORS
- ABS black or in various attractive standard colors



ACCESSORIES
- BlockPack (see page 14)

STANDARD COLORS



DIY-Clips

DIY-Clips – for a firm grip, simple assembly, and perfect product presentation at the point of sale

- DIY-Adapter – plastic euro hanger for in-store display of products with simple round hole on euro hooks
- DIY-Clip for Flat Bits – plastic euro hanger with cable tie
- DIY-Clip for Sockets, Core Drills and Hole Saws – plastic euro hanger with square plug with ribbed surface
- DIY-Clip with Cable Tie – plastic euro hanger with cable tie
- DIY-Perforated Disc – plastic euro hanger with perforated disc with variable perforation for securing product with cable tie
- DIY-UniClip – plastic euro hanger with cable tie and fixing disc
- DIY-PouchClip – plastic euro hanger with hinged lid closure for plastic bags

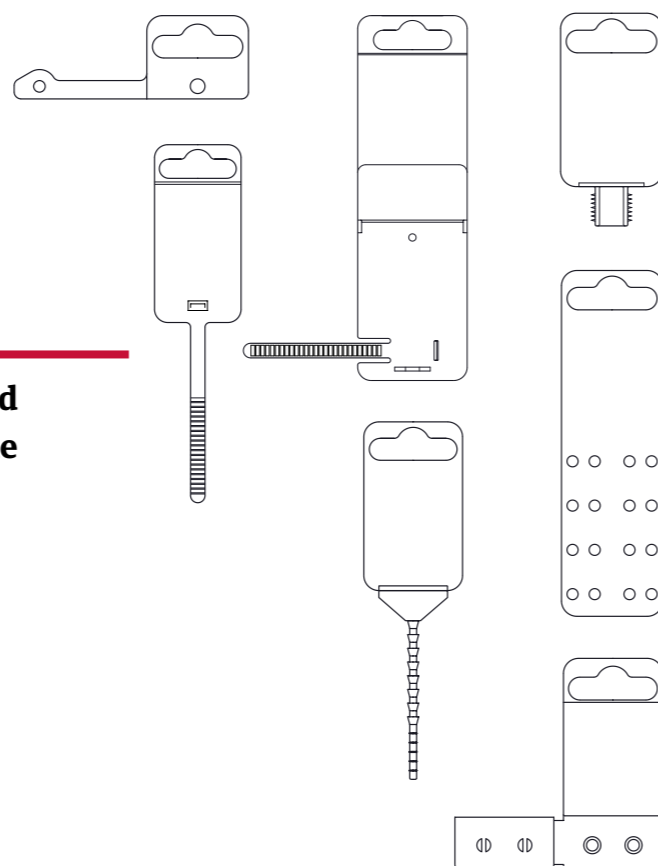

PACKAGING
Carton



MATERIAL
– Polypropylene (PP)



COLORS
– Available in various attractive standard colors – please inquire

STANDARD COLORS



Product Range

1 DIY-Adapter

Article	Hanger length	Hanger width	PU
DYC 36x30/1	30mm	36mm	4000

2 DIY-Clip for Flat Bits

Article	Hanger width	Hanger length	Length of cable tie	PU
DYC 45x150 /1	45mm	150mm	60mm	600

3 DIY-Clip for Sockets, Core Drills and Hole Saws

Article	Suitable for	Hanger length	Hanger width	Tool holder diam.	PU
DYC 36x61 6.3/2	socket	61mm	36mm	6.3mm	3500
DYC 36x61 9.5/2	socket	61mm	36mm	9.5mm	2000
DYC 36x61 12.7/2	socket/core drill M16/ hole saw from Ø 32mm	61mm	36mm	12.7mm	2000
DYC 36x68 14/2	hole saw up to Ø 30mm	68mm	36mm	14mm	3000

4 DIY-Clip with Cable Tie

Article	Hanger width	Hanger length	Length of cable tie	PU
DYC 36x74 075/1	74mm	36mm	75mm	4000
DYC 36x74 115/1	74mm	36mm	115mm	2500
DYC 36x74 150/1	74mm	36mm	150mm	2000

5 DIY-Perforated Disc

Article	Hanger length	Hanger width	PU
DYL 36x123/1	123mm	36mm	500
DYL 60x140/1	140mm	60mm	350

6 DIY-UniClip

Article	Description	Hanger length	Hanger width	Length of cable tie	PU
DYC 36x74 075/2		74mm	36mm	75mm	800
DYC 36x74 150/2		74mm	36mm	150mm	800
DYC 26x12/2	fixing disc	12mm	26mm		5000

7 DIY-PouchClip

Article	Hanger length	Hanger width	PU
DYC 36x77/1	77mm	36mm	2000



These small, practical helpers are reliable product protectors and accomplished salesmen in one



ProtectiveCap



Flexible, light and suitable protection for multiple tool diameters

- suitable for tools from Ø 3 mm up to Ø 30 mm
- the single sizes are suitable for multiple tool diameters
- flexible material for easy assembly and removal
- compatible with our TopPack products



PACKAGING
Available from 1 packaging unit (in bag or carton depending on size)



MATERIAL
- TPE with 40% recycled material / EVA



COLOR
- PCAP Size 01-12: gray
- PCAP Size 13-17: natural

SHANK DIAM.



STANDARD COLOR



Product Range

Article	Suitable for tool diam.	Suitable for no. of edges	Compatible with TopPack	PU (pcs./bag)	PU (pcs./carton)
PCAP Size 01/2	3mm	2 / 3 / 4	TPK 8 / TPK 13	1000	20000
	3,5mm	2 / 4	TPK 8 / TPK 13	1000	20000
	4mm	2	TPK 8 / TPK 13	1000	20000
PCAP Size 02/2	4mm	3 / 4	TPK 8 / TPK 13	1000	20000
	4,5mm	2 / 4	TPK 8 / TPK 13	1000	20000
	5mm	2	TPK 8 / TPK 13	1000	20000
PCAP Size 03/2	5mm	3 / 4 / 6	TPK 8 / TPK 13	1000	20000
	5,5mm	2 / 4	TPK 8 / TPK 13	1000	20000
	6mm	2 / 3 / 4 / 6	TPK 8 / TPK 13	1000	20000
PCAP Size 04/2	6,5mm	2 / 4	TPK 8 / TPK 13	1000	16000
	7mm	2 / 3 / 4	TPK 8 / TPK 13	1000	16000
PCAP Size 05/2	7,5mm	4	TPK 8 / TPK 13	1000	16000
	8mm	2 / 3 / 4 / 6	TPK 8 / TPK 13	1000	16000
PCAP Size 06/2	8,5mm	4	TPK 13	1000	16000
	9mm	2 / 3 / 4	TPK 13	1000	16000
	9,5mm	4	TPK 13	1000	16000
PCAP Size 6.5/2	10mm	2 / 3 / 4 / 6	TPK 13	1000	10000
	10,5mm	4	TPK 13	1000	10000
PCAP Size 07/2	11mm	4	TPK 13	1000	10000
	11,5mm	4	TPK 13	1000	10000
PCAP Size 7.5/2	12mm	2 / 3 / 4 / 5 / 6	TPK 13	1000	10000
	13mm	4	TPK 18	1000	10000
	14mm	2 / 3 / 4	TPK 18	1000	6000
PCAP Size 08/2	15mm	4	TPK 18	1000	5000
	16mm	2 / 3 / 4 / 6	TPK 18	1000	5000
	17mm	2	TPK 18	1000	5000
PCAP Size 10/2	18mm	2 / 3 / 4	TPK 20	500	3000
	19mm	2	TPK 20	500	3000
PCAP Size 11/2	20mm	2 / 3	TPK 20	500	3000
PCAP Size 12/2	20mm	4 / 6	TPK 20	500	2500
PCAP Size 13	22mm				1000
PCAP Size 14	24mm				1000
PCAP Size 15	26mm				750
PCAP Size 16	28mm				600
PCAP Size 17	30mm				500



Looking for reliable protection for tools and their users? Then simply put on the ProtectiveCap!

Protective EndCaps PSC

Protective caps for polygonal taper shank tool holders according to ISO 26623-1

- delicate polygonal taper shank tool holders are protected against dirt and damage during transportation and storage
- incorporated latches prevent unintentional release from the shank
- impact and crack resistant Polyethylene
- speedy handling
- durable and reusable
- sturdy, oil, and moisture resistant



Product Range

Article	Inner diam.	PU
PEPSC 32	32mm	1250
PEPSC 40	40mm	1300
PEPSC 50	50mm	800
PEPSC 63	63mm	350
PEPSC 80	80mm	350



PACKAGING
Carton



MATERIAL
- Polyethylene (PE)



COLORS
- PE gray or in various attractive standard colors

INNER DIAM.

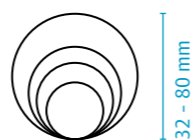

STANDARD COLORS



ERNST RÖSLER
Founder

Foam Inserts

Foam inserts for rose plastic tubes and boxes

- to provide additional protection for products susceptible to damage by impact e.g. carbide tooling, heavy milling cutters, delicate mechanical parts, etc.
- round foam inserts to accommodate diverse packaging tubes (QuadroPack, TwistPack, ScrewPack, TelePack etc.)
- square foam inserts to accommodate UniBox, UniCase etc.



PACKAGING
Completely packed in a carton



MATERIAL
- Foam



COLORS
- Square: white
- Round: white

DIAMETER

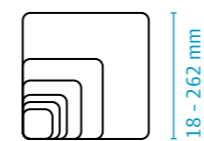

STANDARD COLOR



only shipped with other items due to low cost

Product Range

Square

Article	Outer length	Outer width	Outer height	PU
SE QU 18x5	18mm	18mm	5mm	100
SE QU 25x4	25mm	25mm	4mm	100
SE QU 25x7	25mm	25mm	7mm	100
SE QU 35x4	35mm	35mm	4mm	100
SE QU 38x6	38mm	38mm	6mm	100
SE QU 38x11	38mm	38mm	11mm	100
SE QU 38x14	38mm	38mm	14mm	100
SE QU 48x7	48mm	48mm	7mm	100
SE QU 50x9	50mm	50mm	9mm	100
SE QU 50x18	50mm	50mm	18mm	100
SE QU 63x7	63mm	63mm	7mm	100
SE QU 68x7	68mm	67mm	7mm	100
SE QU 72x13	72mm	72mm	13mm	100
SE QU 72x25	72mm	72mm	25mm	100
SE QU 90x7	90mm	90mm	7mm	100
SE QU 90x12	90mm	90mm	12mm	100
SE QU 103x7	103mm	103mm	7mm	100
SE QU 103x12	103mm	103mm	12mm	100
SE QU 105x15*	105mm	105mm	15mm	100
SE QU 131x7	131mm	131mm	7mm	100
SE QU 131x12	131mm	131mm	12mm	100
SE QU 165x6	165mm	165mm	6mm	100
SE QU 165x12	165mm	165mm	12mm	100
SE QU 165x20	165mm	165mm	20mm	100
SE QU 180x7*	180mm	180mm	7mm	100
SE QU 180x15*	180mm	180mm	15mm	100
SE QU 204x7	204mm	204mm	7mm	100
SE QU 204x12	204mm	204mm	12mm	100
SE QU 262x7	262mm	262mm	7mm	100
SE QU 262x12	262mm	262mm	12mm	100

*color black

Round

Article	Diameter	Outer height	PU	Article	Diameter	Outer height	PU
SE RU 8x9	8mm	9mm	100	SE RU 50x9	50mm	9mm	100
SE RU 10x9	10mm	9mm	100	SE RU 55x9	55mm	9mm	100
SE RU 12x9	12mm	9mm	100	SE RU 60x9	60mm	9mm	100
SE RU 14x9	14mm	9mm	100	SE RU 190x9	190mm	9mm	100
SE RU 16x9	16mm	9mm	100	SE RU 77x9	77mm	9mm	100
SE RU 20x9	20mm	9mm	100	SE RU 88x9	88mm	9mm	100
SE RU 22x9	22mm	9mm	100	SE RU 88x25	88mm	25mm	100
SE RU 25x9	25mm	9mm	100	SE RU 100x9	100mm	9mm	100
SE RU 26x9	26mm	9mm	100	SE RU 110x9	110mm	9mm	100
SE RU 28x9	28mm	9mm	100	SE RU 110x25	110mm	25mm	100
SE RU 30x9	30mm	9mm	100	SE RU 118x9	118mm	9mm	100
SE RU 35x9	35mm	9mm	100	SE RU 133x9	133mm	9mm	100
SE RU 40x9	40mm	9mm	100	SE RU 160x9	160mm	9mm	100
SE RU 45x9	45mm	9mm	100	SE RU 190x9	190mm	9mm	100



Wrapping tools in cotton wool has the same effect – but is much more expensive!

Foam Inserts for SplitPack and FivePack

Foam inserts for rose plastic SplitPack and FivePack

- foam chains for SplitPack and FivePack with 10 resp. 5 foam units
- for additional protection of sensitive cutting edges susceptible to damage by impact
- perfect embedding of the tool when using 2 foams at the front and back
- can be positioned freely in the units, so that even shorter tools can be fixed in the packaging
- much faster to insert than individual foams
- easily separable due to thin connecting strips
- the foam chains for FivePack and SplitPack have to be halved, because these packages have only 5 units



Gently placed in between soft foam inserts, so heavy impacts are safely cushioned



PACKAGING
Completely packed in a carton



MATERIAL
- Foam



COLORS
- silvergray

STANDARD COLOR



Product Range

Article	Outer length	Outer width	Outer height	Number of units	Suitable for	PU
SE RE 76x4x4/9 A.	76mm	4mm	4mm	10	SplitPack 4	1
SE RE 106x7x6/9 A.	106mm	7mm	6mm	10	SplitPack 6 / FivePack 6	1
SE RE 106x7x8/9 A.	106mm	7mm	8mm	10	SplitPack 6 / FivePack 6	1
SE RE 106x7x10/9 A.	106mm	7mm	10mm	10	SplitPack 6 / FivePack 6	1
SE RE 106x7x14/9 A.	106mm	7mm	14mm	10	SplitPack 6 / FivePack 6	1
SE RE 129x9x6/9 A.	129mm	9mm	6mm	10	SplitPack 8	1
SE RE 129x9x8/9 A.	129mm	9mm	8mm	10	SplitPack 8	1
SE RE 129x9x10/9 A.	129mm	9mm	10mm	10	SplitPack 8	1
SE RE 158x11x6/9 A.	158mm	11mm	6mm	10	SplitPack 10 / FivePack 10	1
SE RE 158x11x8/9 A.	158mm	11mm	8mm	10	SplitPack 10 / FivePack 10	1
SE RE 158x11x10/9 A.	158mm	11mm	10mm	10	SplitPack 10 / FivePack 10	1
SE RE 94x14x6/4 A.	94mm	14mm	6mm	5	SplitPack 12 / FivePack 12	1
SE RE 94x14x8/4 A.	94mm	14mm	8mm	5	SplitPack 12 / FivePack 12	1
SE RE 94x14x10/4 A.	94mm	14mm	10mm	5	SplitPack 12 / FivePack 12	1
SE RE 117x18x6/4 A.	117mm	18mm	6mm	5	SplitPack 16	1
SE RE 117x18x8/4 A.	117mm	18mm	8mm	5	SplitPack 16	1
SE RE 117x18x10/4 A.	117mm	18mm	10mm	5	SplitPack 16	1

delivery together with rose plastic SplitPack or FivePack only

Protective Sleeves

Ideal for protection of cutting tips and edges

- additional protection for delicate tool cutting edges
- extensive range of sizes
- quick and easy loading of tools



Product Range

Article	Inner diam.	Outer length	Usable length fixed	PU (pcs./bag)	PU (pcs./carton)
Protective Sleeves Ø 3x20	3mm	19.6mm	12mm	1000	20000
Protective Sleeves Ø 3.175x20	3.175mm	19.6mm	12mm	1000	20000
Protective Sleeves Ø 3x45	3mm	45.2mm	35mm	1000	10000
Protective Sleeves Ø 4x30	4mm	29.5mm	20mm	1000	15000
Protective Sleeves Ø 4x45	4mm	45.2mm	35mm	1000	10000
Protective Sleeves Ø 6x30	6mm	29.5mm	20mm	1000	15000
Protective Sleeves Ø 6x45	6mm	45.2mm	35mm	1000	10000

only shipped with other items due to low cost

 **PACKAGING**
Available from 1 packaging unit (in bag)

 **MATERIAL**
- Polypropylene (PP)

 **COLOR**
- PP transparent

STANDARD COLOR



SDS-Clip

Plastic euro hangers for in-store display of masonry drills, chisels and drill bits

- SDS-plus/top/max with clever plug-in system
- SDS-plus II/max II for extra heavy products and secure hold due to click closure
- attractive sales presentation
- one label suits all sizes of clips (32 x 42 mm)
- easy, efficient handling

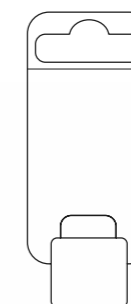

Product Range

Article	Description	Hanger length	Hanger width	Tool holder diam.	PU
DYC 36x74 10/1	SDS-plus	74mm	36mm	10mm	1250
DYC 36x90 10/1	SDS-plus II	91.6mm	38mm	10mm	1000
DYC 36x74 14/1	SDS-top	74mm	36mm	14mm	1500
DYC 36x74 18/1	SDS-max	74mm	36mm	18mm	1500
DYC 40x110 18/1	SDS-max II	110mm	40mm	18mm	1000

 **PACKAGING**
Carton

 **MATERIAL**
- SDS-plus, SDS-top, SDS-max: Polyethylene (PE)
- SDS-plus II, SDS-max II: Polypropylene (PP)
- SDS-plus II, SDS-max II: Polypropylene (PP) made from 100% recycled plastic (post-consumer recycle)



STANDARD COLORS



ToolHolder

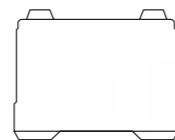

Safer transport of tool holding fixtures!

- ToolHolder in combination with BlockPack provides perfect packaging safety
- tight fit of the tool holders in axial and radial direction
- quick loading, efficient packing, simple removal
- the combination of ToolHolder insert and BlockPack tube reduces the packaging variety and saves warehouse resources
- high quality and sturdy individual packaging
- highly secure closure, but with minimal force in opening and closing the pack
- excellent for stacking and storage
- durable and reusable
- sturdy, oil, and moisture resistant



PACKAGING

ToolHolder as well as BlockPack Outer parts and inner parts (not included in ToolHolder delivery) are packed separately in individual cartons



MATERIAL

- Polyethylene (PE)



COLOR

- ToolHolder insert in black



ACCESSORIES

- BlockPack (see page 14)

TOOL LENGTHS

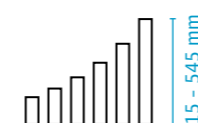

STANDARD COLOR



Product Range

Article	Suitable for	Suitable Block-Pack inner part	Suitable Block-Pack outer part	for tool length (mm)	for tool length (in)	PU			
BK TH 35/1	PSC 32/KM 32/HSK 32	BK 35 050 I	BK 35 050 A	25 - 46	0.98 - 1.81	300			
		BK 35 050 I	BK 35 080 A	52 - 75	2.05 - 2.95				
		BK 35 080 I	BK 35 080 A	52 - 95	2.05 - 3.74				
		BK 35 080 I	BK 35 120 A	95 - 135	3.74 - 5.31				
		BK 35 120 I	BK 35 120 A	95 - 175	3.74 - 6.89				
		BK 35 080 I	BK 35 200 A	175 - 215	6.89 - 8.46				
BK TH 45/1	PSC 40/KM 40/HSK 40	BK 45 060 I	BK 45 060 A	25 - 45	0.98 - 1.77	300			
		BK 45 060 I	BK 45 080 A	45 - 65	1.77 - 2.56				
		BK 45 080 I	BK 45 080 A	45 - 85	1.77 - 3.35				
		BK 45 080 I	BK 45 120 A	85 - 125	3.35 - 4.92				
		BK 45 120 I	BK 45 120 A	85 - 165	3.35 - 6.50				
		BK 45 120 I	BK 45 200 A	165 - 245	6.50 - 9.65				
BK TH 55/1	PSC 50/KM 50/HSK 50	BK 55 060 I	BK 55 060 A	15 - 40	0.59 - 1.57	300			
		BK 55 060 I	BK 55 080 A	40 - 60	1.57 - 2.36				
		BK 55 080 I	BK 55 080 A	40 - 80	1.57 - 3.15				
		BK 55 080 I	BK 55 120 A	80 - 120	3.15 - 4.72				
		BK 55 120 I	BK 55 120 A	80 - 160	3.15 - 6.30				
		BK 55 120 I	BK 55 200 A	160 - 240	6.30 - 9.45				
BK TH 55/2	SK 30	BK 55 060 I	BK 55 080 A	24 - 44	0.94 - 1.73				
		BK 55 080 I	BK 55 080 A	24 - 64	0.94 - 2.52				
		BK 55 080 I	BK 55 120 A	64 - 104	2.52 - 4.09				
		BK 55 120 I	BK 55 120 A	64 - 144	2.52 - 5.67				
		BK 55 120 I	BK 55 200 A	144 - 224	5.67 - 8.82				
		BK 55 200 I	BK 55 200 A	144 - 294	5.67 - 11.57				
		BK 55 200 I	BK 55 350 A	294 - 444	11.57 - 17.48				
		BK 55 350 I	BK 55 350 A	294 - 564	11.57 - 22.20				
		BK TH 65/1	PSC 63/KM 63/HSK 63	BK 65 080 I	BK 65 080 A		25 - 65	0.98 - 2.56	180
				BK 65 080 I	BK 65 120 A		65 - 105	2.56 - 4.13	
BK 65 120 I	BK 65 120 A			65 - 145	2.56 - 5.71				
BK 65 120 I	BK 65 200 A			145 - 225	5.71 - 8.86				
BK 65 200 I	BK 65 200 A			145 - 295	5.71 - 11.61				
BK 65 200 I	BK 65 350 A			295 - 445	11.61 - 17.52				
BK 65 350 I	BK 65 350 A			445 - 545	17.52 - 21.46				
BK TH 65/2	SK 40			BK 65 080 I	BK 65 120 A	40 - 80	0.59 - 2.17	150	
				BK 65 120 I	BK 65 120 A	40 - 120	2.17 - 3.74		
				BK 65 120 I	BK 65 200 A	120 - 200	2.17 - 5.31		
		BK 65 200 I	BK 65 200 A	120 - 270	5.31 - 8.46				
		BK 65 200 I	BK 65 350 A	270 - 420	5.31 - 11.22				
		BK 65 350 I	BK 65 350 A	420 - 520	11.22 - 17.13				
BK TH 85/1	PSC 80/KM 80/HSK 80	BK 85 080 I	BK 85 080 A	15 - 55	1.77 - 4.92	80			
		BK 85 080 I	BK 85 120 A	55 - 95	4.92 - 8.07				
		BK 85 120 I	BK 85 120 A	55 - 135	4.92 - 10.83				
		BK 85 120 I	BK 85 200 A	135 - 215	10.83 - 16.73				
		BK 85 200 I	BK 85 200 A	135 - 285	1.57 - 3.15				
		BK 85 200 I	BK 85 350 A	285 - 435	1.57 - 4.72				
BK TH 105/1	PSC 100/KM 100/HSK 100	BK 105 120 I	BK 105 120 A	45 - 125	4.72 - 7.87	100			
		BK 105 120 I	BK 105 200 A	125 - 205	4.72 - 10.63				
		BK 105 200 I	BK 105 200 A	125 - 275	10.63 - 16.54				
		BK 105 200 I	BK 105 350 A	275 - 425	16.54 - 20.47				
BK TH 105/2	SK 50	BK 105 120 I	BK 105 200 A	83 - 163	3.27 - 6.42	75			
		BK 105 200 I	BK 105 200 A	83 - 233	3.27 - 9.17				
		BK 105 200 I	BK 105 350 A	233 - 383	9.17 - 15.08				



Wondering how to transport tool holders safely from A to B? Here is the solution ...

TopPack FiveFrame

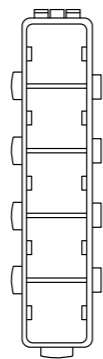

Plastic frame for bundling 5 TopPack packaging tubes

- to combine TopPack 8 or TopPack 13 packaging tubes in units of 5
- the TopPack base plugs snap securely into the FiveFrame and can be released from the frame with a simple push through
- the frames can be connected to each other as using a plug-in function
- several FiveFrames assembled together can be used as assembly aids or in the assembly process for holding stock
- possibility of prefabrication with TopPack base plugs
- easy handling, automated loading
- made of impact-resistant ABS
- reusable, as it can be used several times
- suitable for 5 base plugs from the TopPack family in sizes 8x18 or 13x25



Everything stays in the frame: the sturdy, reusable frame secures five TopPack tubes each



PACKAGING

Carton



MATERIAL

- impact resistant ABS plastic



COLOR

- ABS black or in various attractive standard colors



ACCESSORIES

- TopPack (see page 62)
- TopPack FoldBack (see page 68)
- TopPack XPress (see page 74)

STANDARD COLOR



Product Range

Article	Suitable for	Outer length	Outer width	Outer height	PU
TKFF 8/1	5x TopPack 8x18	77mm	20mm	11mm	1000
TKFF 13/1	5x TopPack 13x25	105mm	25mm	13mm	700

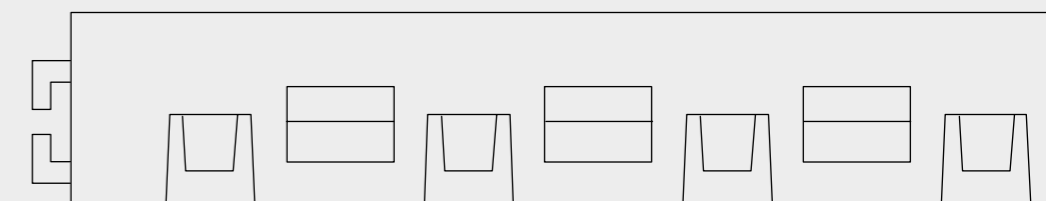
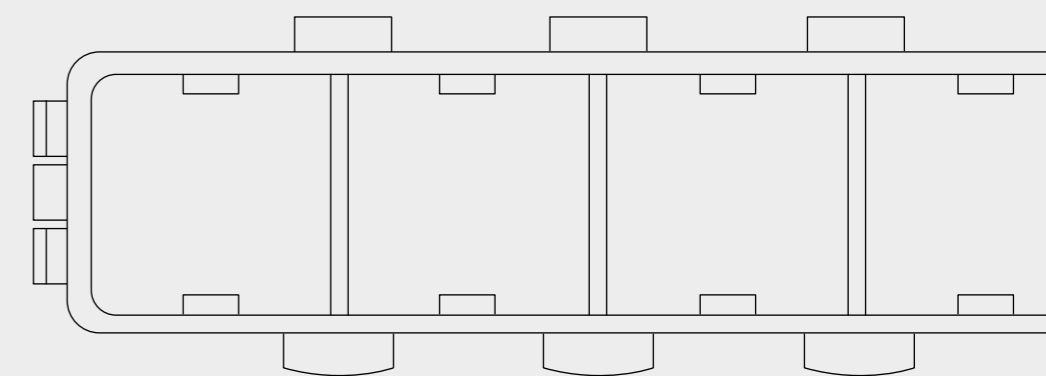



HEADQUARTERS
Germany

Production locations

GERMANY

rose plastic AG

Rupolzer Straße 53
88138 Hergensweiler/Lindau
Tel. +49 8388 9200-0
info@rose-plastic.de

USA

rose plastic USA, L.L.L.P.

P.O. Box 698
California, PA 15419-0698
Tel. +1 724 938 8530
info@rose-plastic.us

CHINA

rose plastic (Kunshan) Co., Ltd.

Donghui Road No. 101, Zhoushi Town,
Kunshan, Jiangsu Province
Tel. +86 512 5766 7700
info@rose-plastic.cn

BRAZIL

rose plastic Brasil Embalagens Plásticas Ltda.

Av. Garabed Ganiam 514, Jardim Topázio
CEP 18087-340 Sorocaba SP
Tel. +55 15 3238 1900
info@rose-plastic.com.br

INDIA

rose plastic India Pvt. Ltd.

Pargaon, Khandala, Satara - 412802
Maharashtra - India
Tel. +91 21 6929 9151
info@rose-plastic.in

Subsidiaries

UNITED KINGDOM

rose plastic UK Ltd.

Unit 4, Bessemer Way, Bessemer
Business Park, Rotherham, S60 1EN
Tel. +44 1709 7217 94
info@rose-plastic.co.uk

FRANCE

rose plastic France S.A.R.L.

Parc d'Activités du Rotey
73460 Notre Dame des Millières
Tel. +33 479 3848 01
info@rose-plastic.fr

SPAIN

rose plastic Iberia, S.L.U.

P.A.E. Ibarrabari, Pab. 15B
48940 Leioa (Vizcaya)
Tel. +34 94 480 66 61
info@rose-plastic.es

REPUBLIC OF KOREA

rose plastic Korea Co., Ltd.

Bucheon Techno Park 402-B01, B02,
Pyung-Cheon Ro 655, Won-mi-gu,
Bucheon City, Gyung-gi-do, ROK 14502
Tel. +82 32 324-8332
info@rose-plastic.kr

ITALY

rose plastic Italia S.r.l.

Viale De Gasperi 103
20017 Rho (MI)
Tel. +39 02 9390 9450
info@rose-plastic.it

Sales partners

JAPAN

Honda Plus Co.Ltd.

23-2 Kawaji Yato
Shinshiro Pref. Aichi 441-13
Tel. +81 5362 31351
info.jp@rose-plastic.com

POLAND

Leniar International Sp. z o.o. Sp.K.

Ul.Szlak 67
31-153 Kraków
Tel. +48 12 6331 670
info.pl@rose-plastic.com

TURKEY

Tureks Endüstriyel Ürünler Pazarlama Ve Dış Ticaret A.Ş.

1471 Sokak No. 7 K:5 D:13
Kenet Sitesi
35220 Alsancak - Izmir
Tel. +90 232 464 5220
info.tr@rose-plastic.com



03/2025

www.rose-plastic.com

rose  plastic®
protective packaging pioneers